

# Methane Monitor

Models: M80-XP

User's Manual



Revision 0  
January 05, 2020



# Table of Contents

<b>1.0 – Introduction.....</b>	<b>1</b>
1.1 – About This Manual .....	1
1.2 – Warranty and Liability Statements .....	1
1.21 – Limitation of Warranty .....	1
1.22 – Disclaimer .....	2
1.3 – Safety Information.....	2
1.31 – Key Symbols.....	2
<b>2.0 – Equipment Overview.....</b>	<b>3</b>
2.1 – Theory of Operation .....	3
2.2 – Equipment Diagrams.....	4
2.3 – Technical Specifications.....	5
<b>3.0 – Installation.....</b>	<b>6</b>
3.1 – Unpacking.....	6
3.2 – Site Requirements .....	6
3.3 – Mounting Requirements.....	7
3.4 – Electrical Connections.....	9
3.5 – Sample Conditioning Requirements.....	15
<b>4.0 – Operation.....</b>	<b>17</b>
4.1 – Start-Up Procedure.....	17
4.2 – Local Operator Interface .....	18
4.21 – Adjustable Menu Values .....	18
4.22 – Alarm Set Points .....	19
4.3 – Software Interface .....	19
4.4 – Calibration Procedure .....	20
<b>5.0 – Maintenance .....</b>	<b>22</b>
5.1 – Monthly Check-Up .....	23
5.2 – Spare Parts and Consumables .....	23
5.3 – SCS Filter Replacement Procedure .....	24
5.4 – Sensor Replacement Procedure .....	26
5.5 – Sample Conditioning System Cleaning Procedure .....	28
<b>6.0 – Troubleshooting .....</b>	<b>30</b>
<b>Appendix A – Standard Modbus Register Map .....</b>	<b>31</b>
<b>Appendix B – Risk Assessment .....</b>	<b>32</b>
<b>Appendix C – Certifications .....</b>	<b>35</b>
<b>Appendix D – Sealing Compound Information .....</b>	<b>37</b>
<b>Contact Us.....</b>	<b>44</b>

# List of Tables and Figures

Figure 2.1 – M80-XP CH <sub>4</sub> Sensor .....	3
Figure 2.2 – M80-XP Internal Component Diagram.....	4
Figure 2.3 – M80-XP External Component Diagram .....	4
Figure 3.1 – M80-XP Mounting Dimensions .....	8
Figure 3.2 – AC Power with Self Powered Analog Output.....	10
Figure 3.3 – AC Power with Loop Powered Analog Output.....	11
Figure 3.4 – DC Power with Self Powered Analog Output.....	12
Figure 3.5 – DC Power with Loop Powered Analog Output .....	13
Figure 3.6 – Powered Solid State Wiring Examples.....	14
Figure 3.7 – Recommended SCS Layout for M80-XP .....	16
Figure 3.8 – PI&D for the Recommended SCS .....	16
Figure 4.1 – Display Menu Diagram.....	18
Table 4.2 – Display Menu Outputs and Descriptions .....	19
Figure 4.3 – Calibration Reference Diagram.....	20
Table 5.1 – Spare Parts and Consumables Summary .....	23
Figure 5.2 – SCS Filter Replacement Reference Diagram .....	24
Figure 5.3 – Microfibre Coalescing Filter Element Diagram.....	25
Figure 5.4 – CH <sub>4</sub> Sensor Replacement for the M90-XP .....	26
Table A1 – Modbus Output Status (Coils).....	31
Table A2 – Modbus Output Registry Numbers .....	31
Table B1 – Risk Matrix .....	32
Table B2 – Situational Risk Assessment.....	32
Table B3 – Physical Properties of Hydrogen Sulfide (H <sub>2</sub> S).....	34
Table B4 – Health Effects of Hydrogen Sulfide (H <sub>2</sub> S) at Varying Concentrations.....	34

# 1.0 Introduction

---

## 1.1 About This Manual

This manual provides all information necessary for the installation, operation, maintenance, and basic troubleshooting of the Envent Engineering M80-XP Methane Monitor.

This manual contains information essential to the safe and efficient operation of the M80-XP. This manual should be read by all personnel who will be installing, operating, or otherwise interacting with either the M80-XP.

This manual focuses on the M80-XP analyzer as a stand-alone unit. However, the sample gas must be conditioned before entering the analyzer to prevent erroneous methane readings and/or damage to the analyzer. This manual includes a recommended sample conditioning system configuration that would ensure proper operation of the analyzer. The exact sample conditioning system used will depend on the customer's requests at time of purchase. Refer to the analyzer's documentation for more information.

## 1.2 Warranty and Liability Statements

Products produced and supplied by the manufacturer (Envent Engineering Ltd), unless otherwise stated, are warranted against defects in materials and workmanship for up to 18 months from the shipping date or up to 12 months from the start-up date (whichever comes first). During the warranty period the manufacturer can choose to either repair or replace products which prove to be defective. The manufacturer or its representative can provide warranty service at the buyer's facility only upon prior agreement. In all cases, the buyer has the option of returning the product for warranty service to a service facility designated by the manufacturer or its representative. The buyer shall prepay all shipping charges for products returned to a service facility. The manufacturer or its representative shall pay all shipping charges for the return of products to the buyer. The buyer may also be required to pay round-trip travel expenses and labour charges (at prevailing labour rates) if the warranty has been violated. The warranty may be considered violated for any of the reasons listed below.

### 1.21 Limitation of Warranty

The foregoing warranty shall not apply to defects arising from:

- Improper or inadequate maintenance of the product by the user
- Improper unpacking or installation procedures
- Inadequate site preparation
- Unauthorized modification or misuse of the product
- Operation of the product in unfavorable environments such as at high temperatures, high humidity, or in corrosive atmospheres
- Operation of the product outside of the published specifications

Envent Engineering Ltd carries no responsibility for damage caused during transportation or unpacking, unless otherwise specified in the incoterms.

An extended warranty may be available with certified start-up. Contact Envent Engineering Ltd for details.

Envent Engineering Ltd reserves the right to change the product design and specifications at any time without prior notice.

## **1.22 Disclaimer**

No other warranty is expressed or implied. The manufacturer specially disclaims the implied warranties of merchantability and fitness for a particular purpose. The sole remedy of the buyer shall in no case exceed the purchase price of the analyzer. The manufacturer shall not be liable for personal injury or property damage suffered in servicing the product. The product should not be modified or repaired in any manner differing from procedures established by the manufacturer.

## **1.3 Safety Information**

The procedures and settings outlined in this manual constitute what is considered proper use of the equipment in question. The equipment was designed and tested under the assumption that these procedures and settings will be adhered to. Applying values outside of the provided ranges (such as permitting excessive pressures) or modifying provided procedures is considered improper use of the equipment. Envent Engineering Ltd is not responsible for any injury or property damage caused by improper use of the equipment. Once in the field, the user is solely responsible for the safe operation of the equipment.

### **1.31 Key Symbols**

The following symbols are used throughout the manual to call attention to important information. We recommend familiarizing yourself with them before reading further.



**Indicates a potential hazard that, if not properly addressed, could result in damage to the equipment or injury to the operator.**



**Indicates additional information intended to help clarify an earlier statement or to aid in the reader's understanding of a given topic.**

## 2.0 Equipment Overview

---

The M80-XP monitors the concentration of methane ( $\text{CH}_4$ ) in natural gas applications and reports this concentration in ppm (with a range of 0 – 100%). The design of the system dramatically reduces the need for calibration by incorporating subsystems that automatically accommodate for environmental factors and drift. See Section 2.1 for further details.

### 2.1 Theory of Operation

All gases demonstrate consistent and specific behaviors when interacting with infrared energy.  $\text{CH}_4$  for instance absorbs energy from within specific regions of the infrared spectrum and the magnitude of this absorption is directly proportional to the amount of  $\text{CH}_4$  present. As a result, it is possible to detect the presence of  $\text{CH}_4$  in a gaseous mixture and measure its concentration by passing infrared light through a sample of said mixture. This is the fundamental principle of the infrared gas sensors that serve as the  $\text{CH}_4$  detection system of the M80-XP. The sensor is classified as a dual wavelength design.

A dual wavelength  $\text{CH}_4$  sensor is comprised of an infrared source, a gas sampling cell, two infrared filters, and a matched twin element detector. During use, the output of the infrared source passes through the sample gas where specific wavelengths are absorbed by any present  $\text{CH}_4$ . The radiation is then processed by the pair of filters before moving on to the twin element detector. One of these filters only allows the wavelengths affected by  $\text{CH}_4$  to pass through. The other only allows the wavelengths unaffected by  $\text{CH}_4$  to pass through. The twin element detector then converts the intensity of the light passing through each of the filters into an electrical signal.



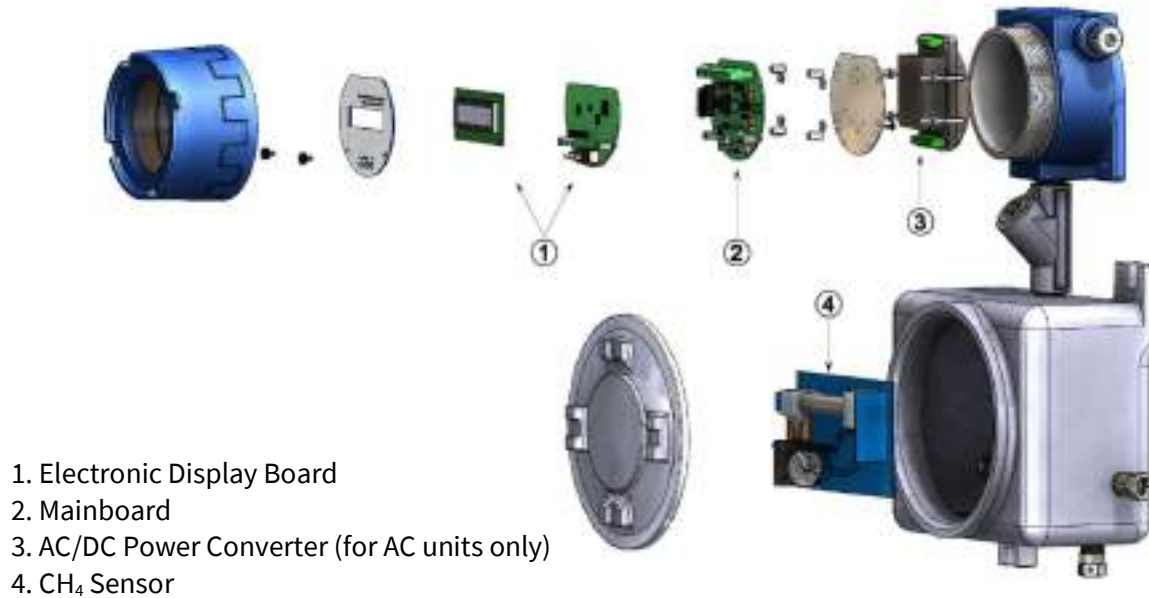
**Figure 2.1: M80-XP  $\text{CH}_4$  Sensor**

The output of the sensor is then passed to the on board microprocessor of the M80-XP. The microprocessor compares the output of each detector element. In the absence of  $\text{CH}_4$ , the output of the detector will be equal for each element. If  $\text{CH}_4$  is present in the sample, there will be a corresponding difference in the output of the sample detectors. The magnitude of this difference is proportional to the concentration of  $\text{CH}_4$  and the on board microprocessor converts this difference into a usable value.

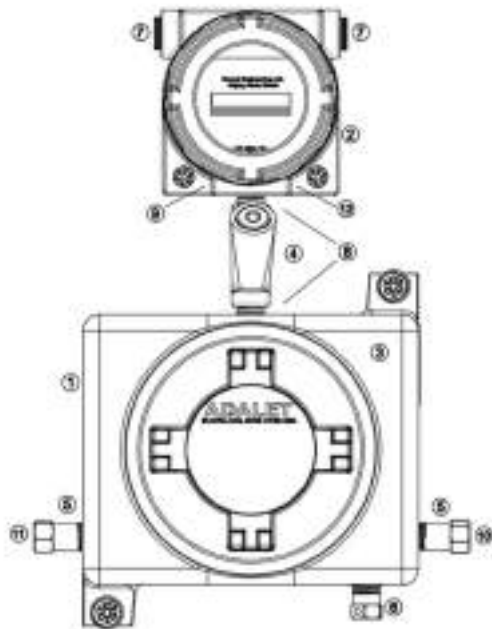
A benefit of this design is that it guarantees that the sensor optics are resistant to drift. Any shift in source intensity will affect both the reference and the sample measurement equally and will be cancelled out in the subsequent concentration calculation. As for environmental factors, the sensor come equipped with on board temperature sensors and pressure sensors. These allow for the

measurement and subsequent compensation of these variables guaranteeing accurate measurements over a wide range of environmental conditions.

## 2.2 Equipment Diagrams



**Figure 2.2: M80-XP Internal Component Diagram**



1. ETL cCSAus nameplate
2. Upper XP enclosure for display and electronics
3. Lower XP enclosure for CH<sub>4</sub> sensor (%)
4. Conduit seal
5. Flame arrestor
6. Drain/breather
7. 3/4" - 14 NPT conduit entries with plugs
8. Rigid conduit nipples
9. External ground connection
10. 1/4" NPT female sample inlet
11. 1/4" NPT female sample outlet
12. Analyzer serial number tag location

**Figure 2.3: M80-XP External Component Diagram**



## 2.3 Technical Specifications

Performance	
Measurement Range (CH <sub>4</sub> )	Standard: 0 – 100 %
Accuracy	± 2% of range or ± < 0.015% of range per mbar
Repeatability	At zero: ± 0.3% of reading, at span: ± 1.5%
Response Time	10 seconds to 90% of step change <sup>(1)</sup>
Application Data	
Environmental Temperature Range	Standard: 0 – 50°C
Operating Range for Sample Inlet Pressure and Flow Rate	10 – 15psig, constant flow rate of 200 – 500cc/min
Maximum Values for Sample Inlet Pressure and Flow Rate	16.5psi, flow rate of 1200cc/min
Contaminant Sensitivity	Resistant to the gaseous forms of mercaptans, methanol, glycol, and amines
Electrical and Communications	
Supply Voltages	12 – 24 VDC 120 – 240 VAC, 50/60 Hz
Outputs	4-20 mA loop powered (concentration only) Standard: Serial RS-232 (all parameters) Dual 3 amp Solid State Alarm Relays Modbus RTU RS485
Data Logging	Data is archived every 10 minutes and stored for 50+ days <sup>(2) (3)</sup>
LCD Display	Dual-line, 16 Character Display Line 1: CH <sub>4</sub> concentration Line 2: Alarm State, Raw mV, Alarm Set Point(s), Calibration Zero, Calibration Span, AO Span Value
Area Classification	
Certification	cETLus Class 1, Division 1, Groups C&D, Temp Code T3 (Tamb 0°C to 50°C) - For Indoor Use

(1) Based on the response time from the inlet of the analyzer. Response times may increase based on the sample conditioning system installed.

(2) Data Logger can be configured to 1 minute, 5 minute, 10 minute, 15 minute, 20 minute, 30 minute, hourly, or daily intervals

(3) Requires Serial Cable, ICE M90-XP GUI software and a computer (not included)

## **3.0 Installation**

---

### **3.1 Unpacking**

Upon arrival, the packaging should be immediately inspected for any external damage that may have occurred during shipping. If any damage is present, please contact Envent Engineering Ltd and request that the carrier's agent be present when the analyzer is unpacked. If a disagreement arises, the incoterms agreed to by the seller and the customer will overrule any dispute.

Once the integrity of the packaging has been confirmed, open the shipping container and remove the packing materials from the shipping box. Remove all provided components from the shipping container and inspect them for any damage that may have been sustained during shipping. Compare the provided components to the shipping manifest to ensure that all parts are present.

### **3.2 Site Requirements**

The M80-XP is designed for cETLus Class 1, Division 1, Groups C&D, Temp Code T3 (Tamb 0°C to 50°C). The M80-XP is designed for indoor use only. Ensure that the analyzer received is suitable for the electrical classification of the installation site.

## 3.3 Mounting Requirements

---



The analyzer should be mounted in an enclosed area in which it is not exposed to vibrations, excessive pressures, temperatures, or environmental variations.

The selected installation site should provide adequate room for maintenance and repair procedures.

The installation site should be as close as possible to the process stream being measured. The sample delivered to the analyzer must be representative of the stream and as such, should be taken from a point as close as possible to the analyzer. This proximity will prevent lag times and sample degradation in the lines.

No modifications or repairs to the flamepaths are permitted.

Substitution of components may impair flameproof safety and suitability for Class I, Division 1.

All NPT thread entries must meet the minimum requirement of 5 threads.

XP enclosures must have conduit plugs installed for unused conduit entries.

Conduit seal(s) must be installed at a minimum distance of 18" from any XP enclosure's conduit entries.

Conduit seals must be poured after wiring is completed and before powering up the unit. Refer to Appendix D for more information on the conduit sealing compound.

The XP enclosure covers must be installed and fully engaged to maintain area classification. They must be secured with the provided 6/32 x 1/2 set screw. A 1/16 hex key is required for removal.

When operating in low temperatures the flame arrestors and sample inlet line must be properly insulated to prevent the cooling of the sample gas.

---

Dimensions in inches [cm in brackets]

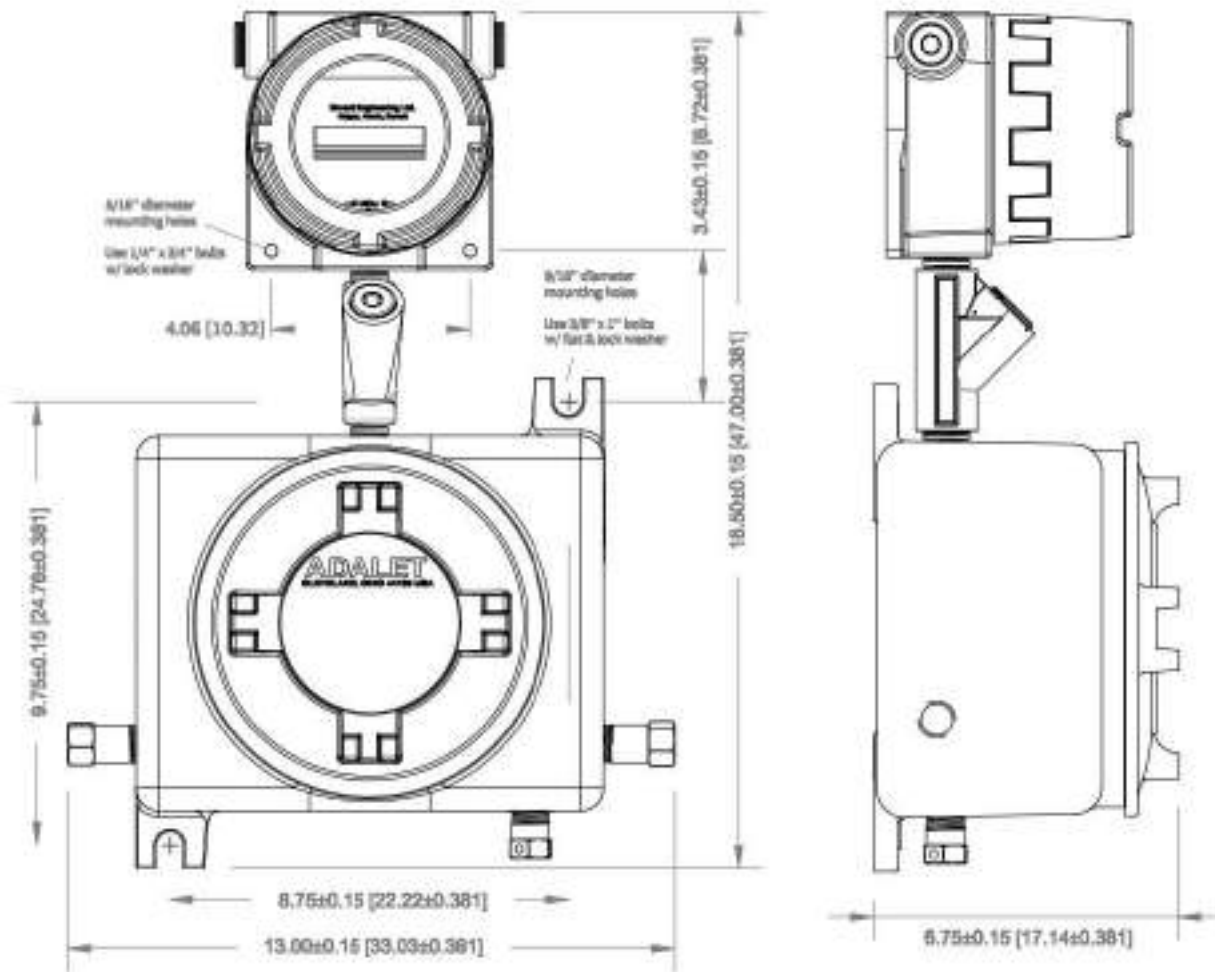


Figure 3.1: M80-XP Mounting Dimensions

## 3.4 Electrical Connections

The figures on the subsequent pages show all of the default customer connections:

---



For 12 – 24VDC powered analyzers: A disconnect device rated 24 VDC and 5A max is required and is to be installed in accordance with local electrical codes.

For 120 – 240VAC powered analyzer: A disconnect device rated 240 VDC and 2A max is required and is to be installed in accordance with local electrical codes.

Do not disconnect equipment unless the power has been switched off or the area is known to be non-hazardous.

Resistance to earth at any point on any exposed metal part should be less than  $10^{-9}$  ohms

External ground wiring must be 12-10 awg (3.3088 – 5.2612 mm<sup>2</sup>). Use provided 10x24 – 1/4” screw with ext #10 washer and 12-10 awg ring connector).

Devices installed to the powered solid state connectors on the mainboard (P6) must be suitable for the electrical classification of the installation site. The M90-XP is designed for Class 1, Division 1, Groups C&D, Temp Code T3 (Tamb 0°C to 50°C).

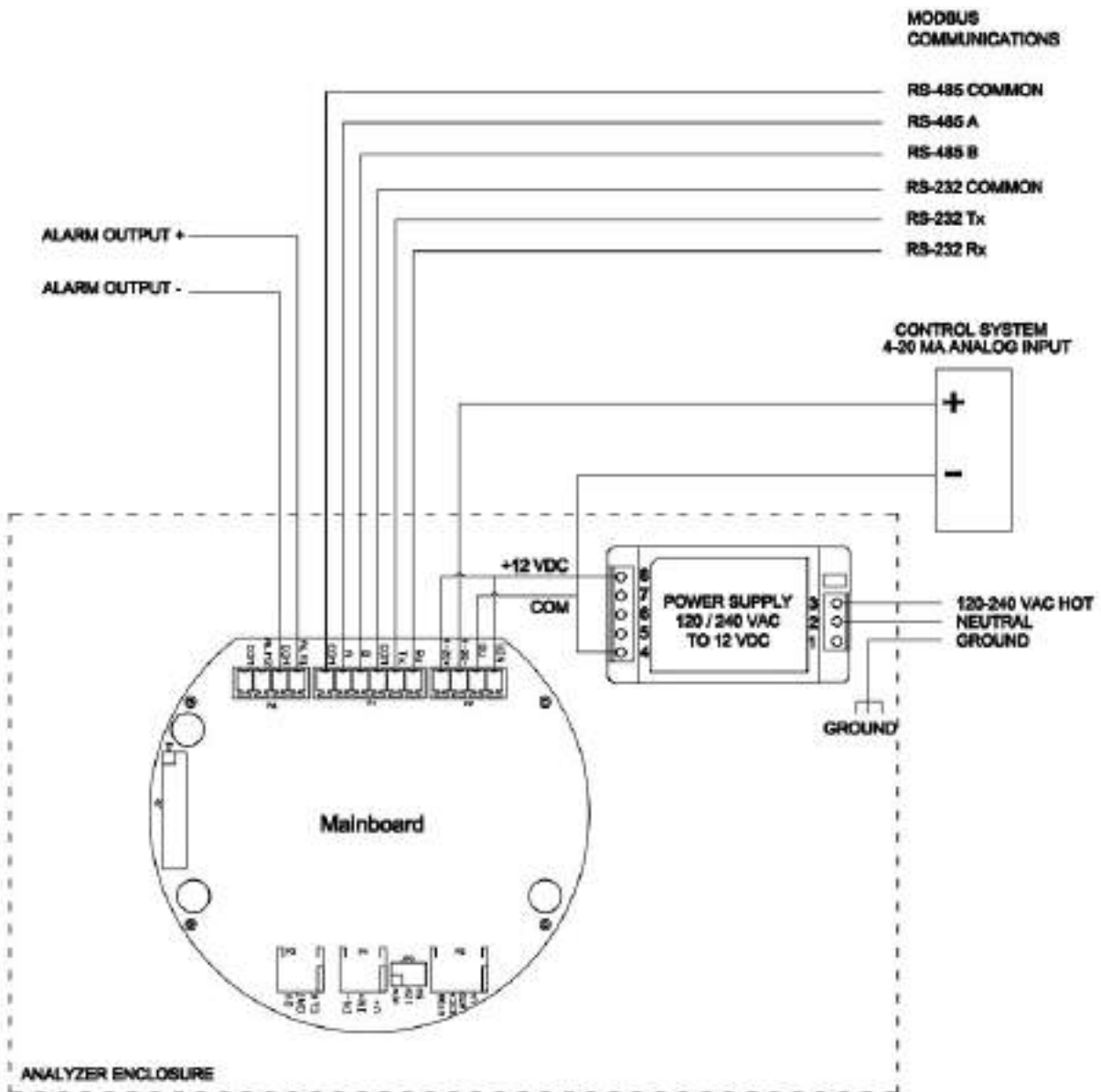
---



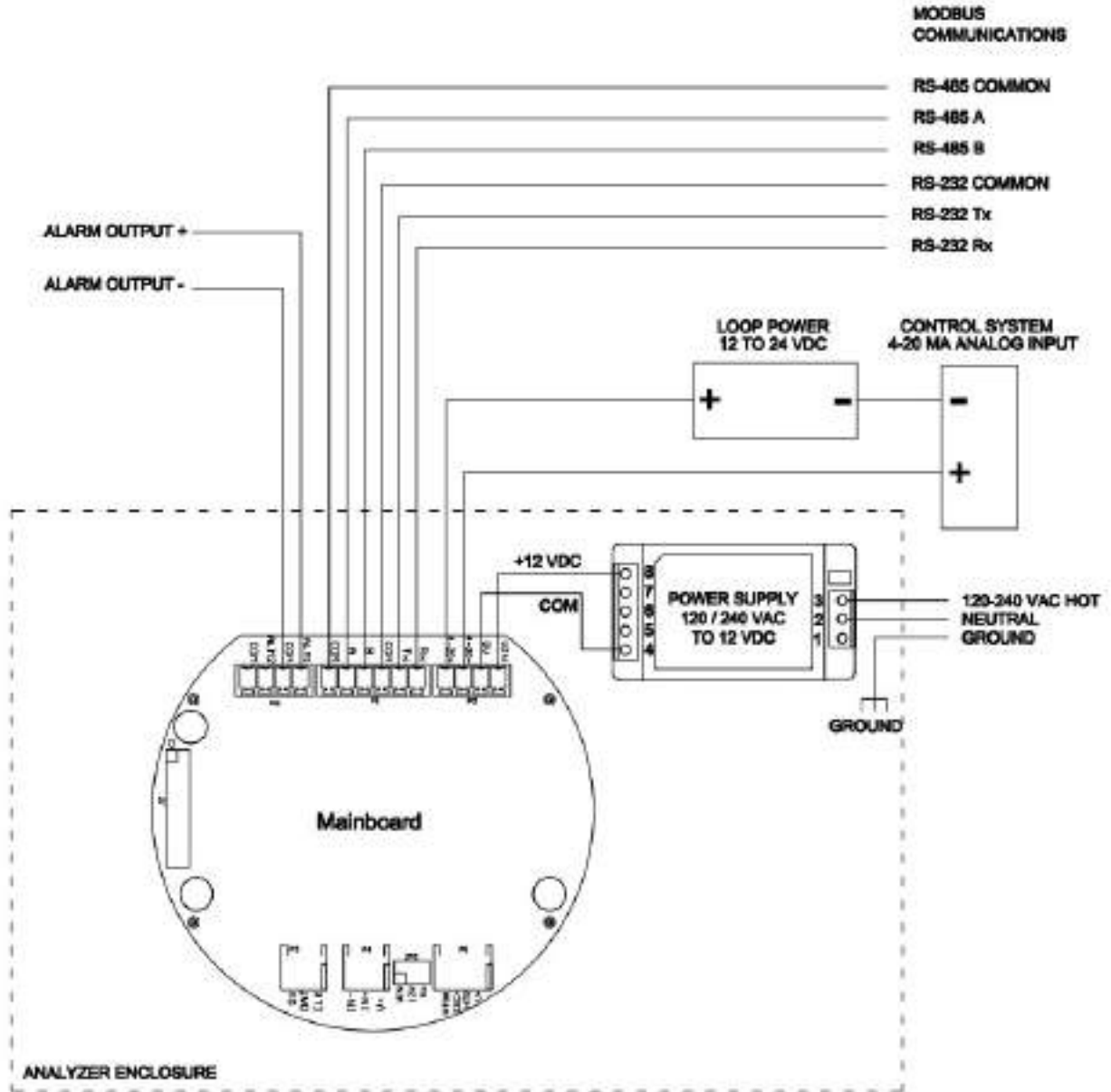
If you have unreliable power, consider using a backup battery or an uninterrupted power source.



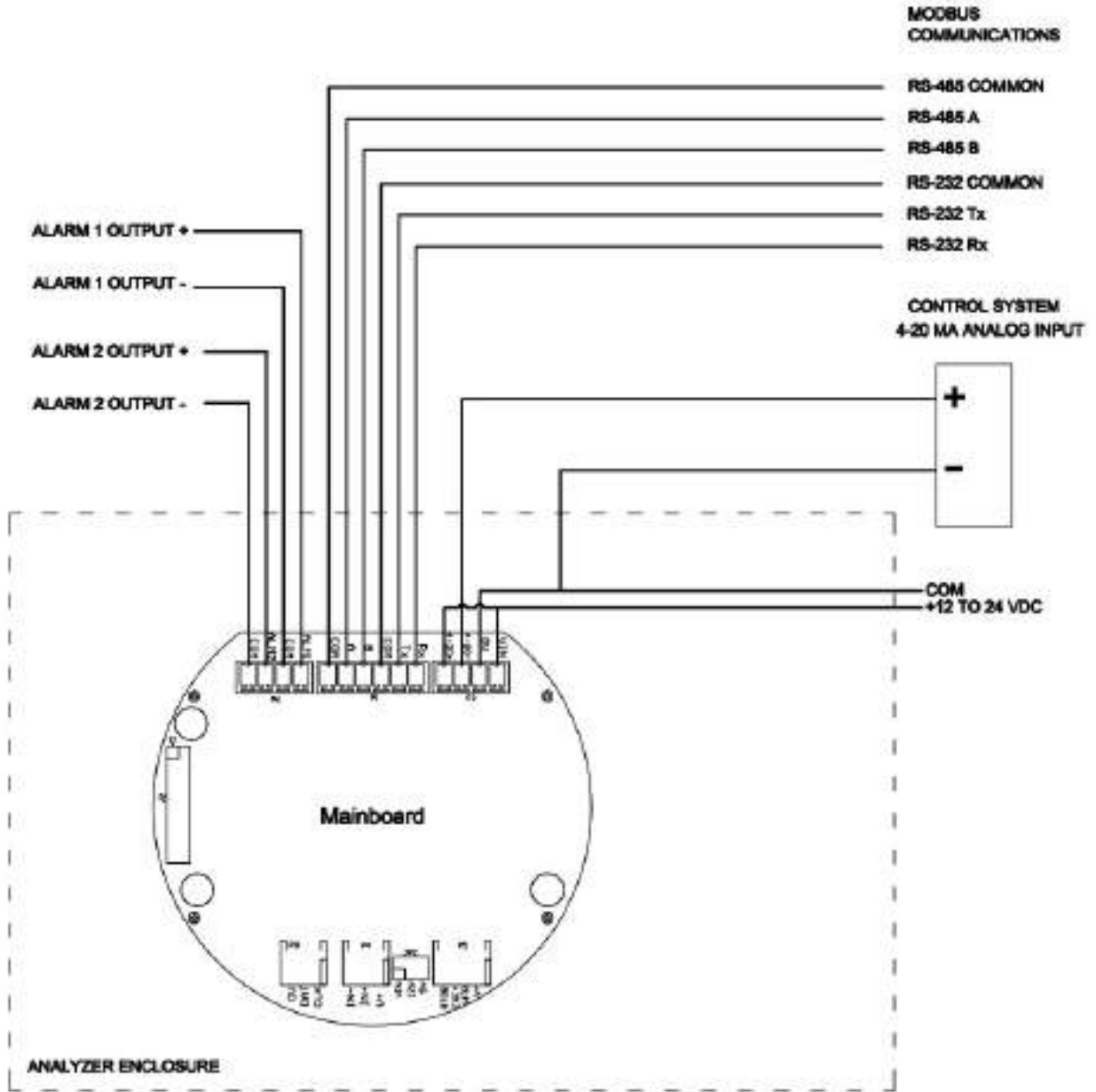
The 4-20 mA output requires a 24 VDC power loop which can be supplied by the analyzer.



**Figure 3.2: AC Power with Self Powered Analog Output**

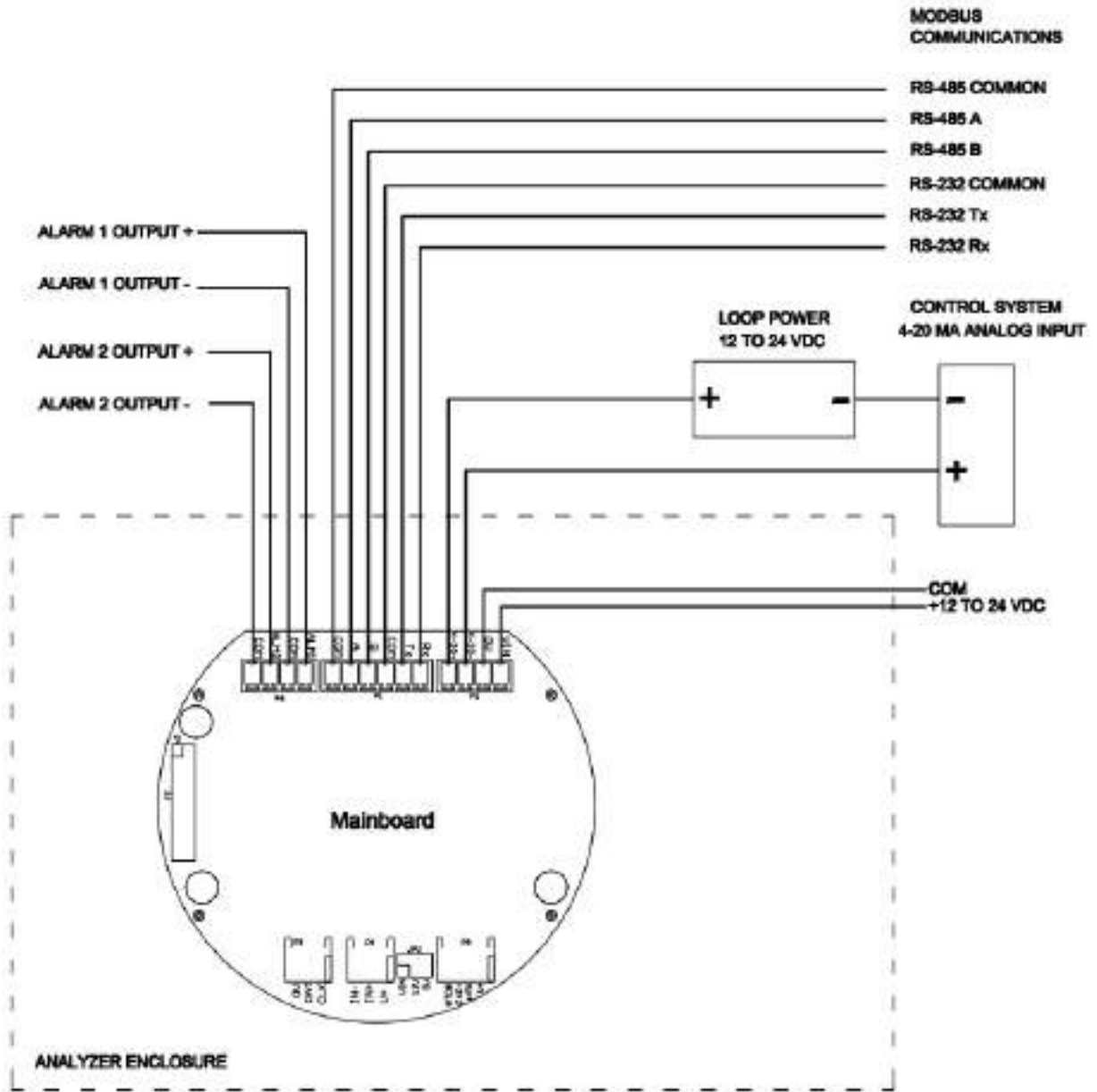


**Figure 3.3: AC Power with Loop Powered Analog Output**

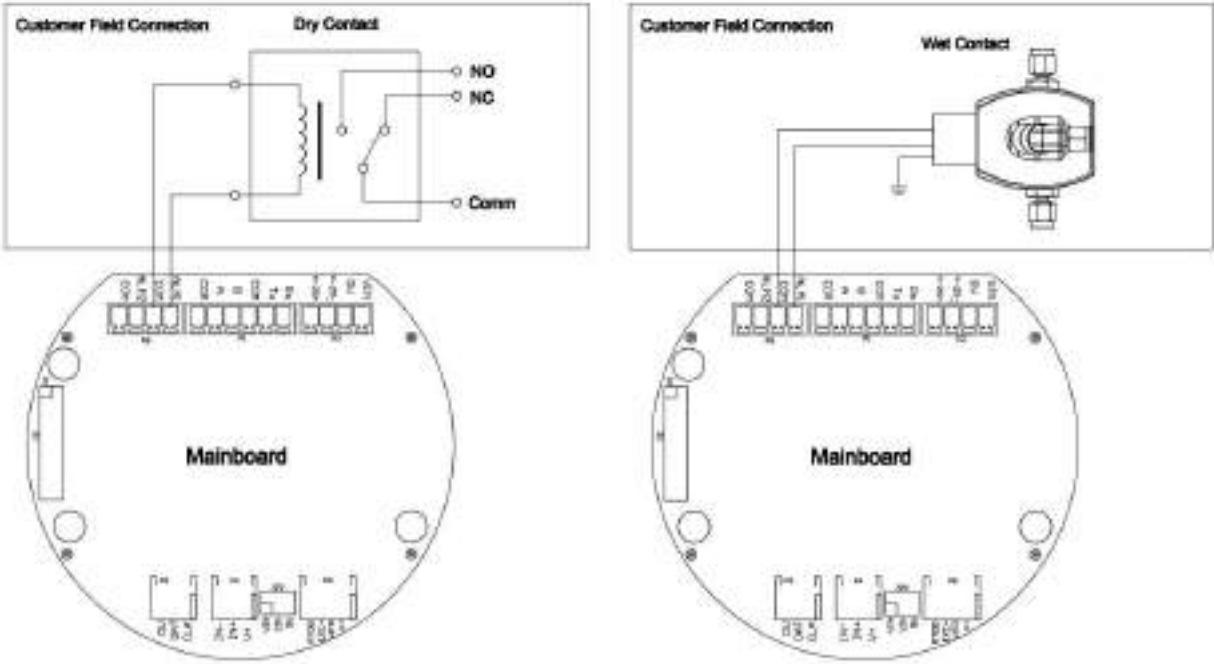


**Figure 3.4: DC Power with Self Powered Analog Output**





**Figure 3.5: DC Power with Loop Powered Analog Output**



**Figure 3.6: Powered Solid State Wiring Examples**

## 3.5 Sample Conditioning Requirements

The presence of a non-ideal sample gas may necessitate the inclusion of a sample conditioning system (SCS). The SCS is an optional module designed to:

- Isolate the sample inlet gas from the analyzer.
- Filter particulate or free liquids from the sample.
- Lower and control the sample pressure and flow rate into the analyzer.
- Increase or decrease the lag time of analyzer response as needed.
- Allow for the calibration of the analyzer without having to dismantle the sample conditioning system.

Figures 3.8 (found on the next page) show the recommended SCS layout for the M80-XP.

Figure 3.8 show a representation of the sample conditioning system which is generic, please refer to the analyzer documentation provided at time of purchase for more information on the sample conditioning system and the analyzer.



Refer to Section 2.3 for more information on the analyzer's pressure and flow requirements.

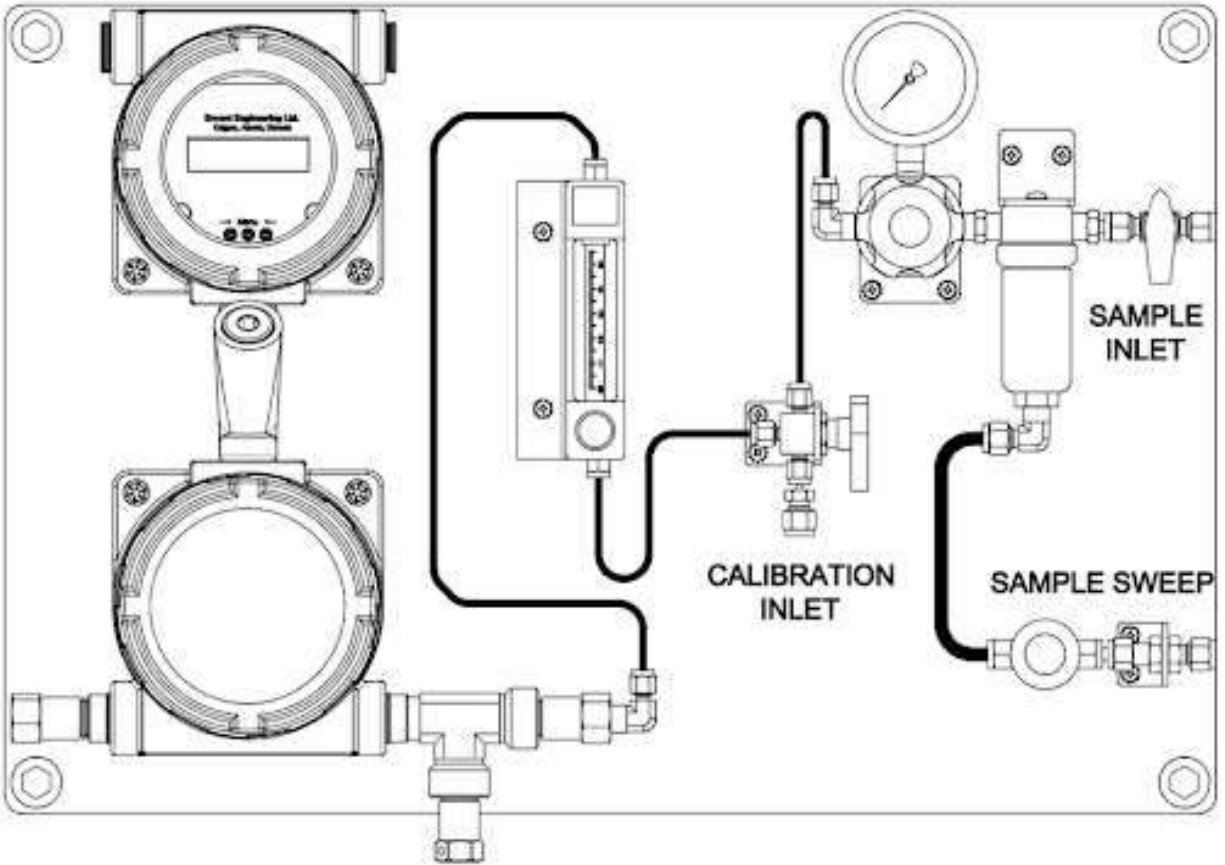


**Sample gas must be supplied at 10 – 15psig (16.5psig max) with a constant flow rate of 200 – 500cc/min (1200cc/min max). Values in excess of these may result in damage to the CH<sub>4</sub> sensor.**

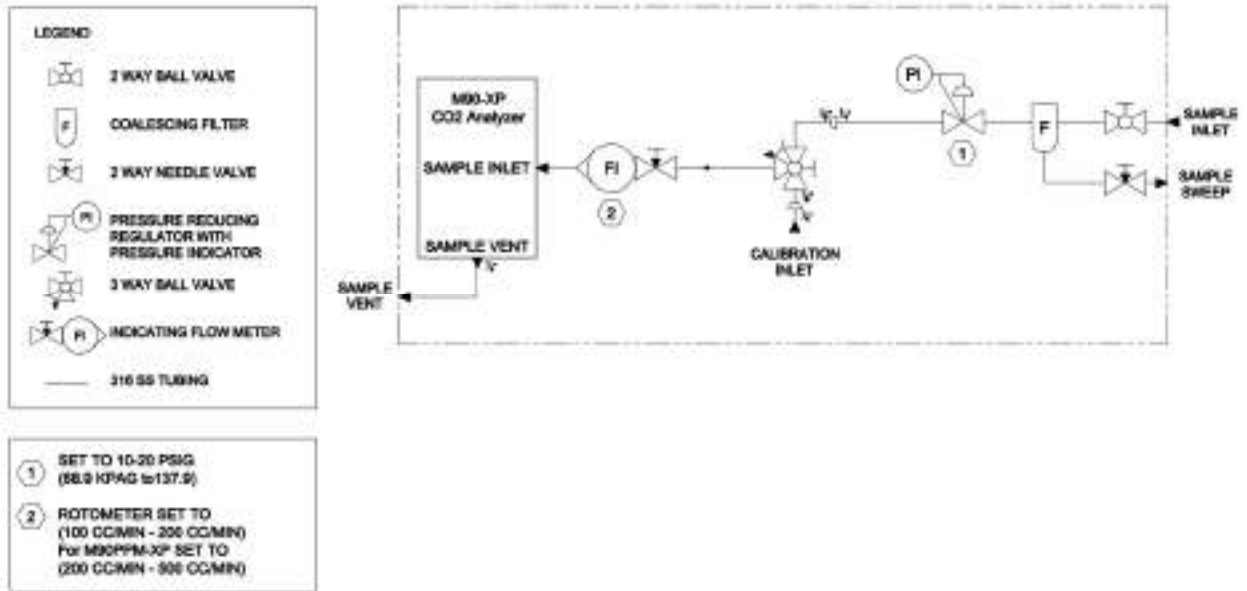
**A bypass sweep is recommended to reduce sample lag time if the sample lines are longer than 15 feet or if they are being kept at high pressure (400psig and above). If the line pressure is over 400 psig, a heated regulator is recommended.**

**All connections must be leak tight to ensure the safety of the user and the operation of the analyzer.**

---



**Figure 3.7: Recommended SCS Layout for M80-XP**



**Figure 3.8: P&ID for the Recommended SCS**

## 4.0 Operation

---

The output of the M80-XP will vary slightly with pressure applied to the sample vent. It is recommended to operate the system at atmospheric pressure to reduce this effect.

### 4.1 Start-Up Procedure

---



Before commencing the start-up procedure for the analyzer, please ensure that all sections within “Installation” (Sections 3.0 – 3.5) have been understood and addressed. Do not proceed until this is done as significant safety hazards can arise if the analyzer is not properly set-up prior to start-up.

During start-up, it is possible that the analyzer and/or the SCS will be contaminated with a scavenger solution. The flow meter should be inspected for liquids to ensure that the float moves freely. If the system has been contaminated, please refer to the Section 5.5 for the SCS cleaning procedure.

---

**Step 1.** When the analyzer is powered on for the first time the system will perform a self-diagnostic procedure. During this procedure the display will show a flashing message of “Envent Engineering”, Model #, Revision.



After the system is powered on for the first time the output will be erratic until the internal signal-averaging buffer is filled. This process will take approximately 5 minutes.

**Step 2.** Once the self-diagnostic procedure is complete, the display will show CH<sub>4</sub> concentration on the first line and another variable or status on the second line.



The second line of the display can be cycled to display various machine settings and outputs. See Section 4.2 for further details.

**Step 3.** Perform a zero/span calibration on the analyzer. Refer to Section 4.4 for further details. This step is recommended but not required. A calibration was performed prior to shipping.

**Step 4.** Turn on the sample gas inlet.

**Step 5.** Set the sample inlet pressure. The recommended value 15 psig. See Section 2.3 for the range of acceptable values.

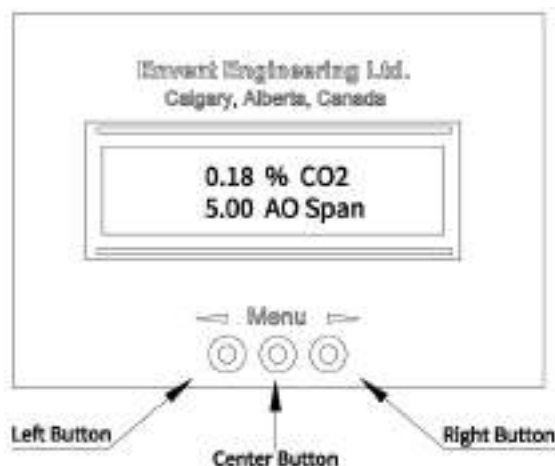
**Step 6.** Set the sample flow rate. The recommended value is 200cc/min. See Section 2.3 for the range of acceptable values.

**Step 7.** Confirm that the 4ma – 20ma output matches the display reading for CH<sub>4</sub> span as indicated in the factory calibration data sheet.

The start-up procedure is now complete.

## 4.2 Local Operator Interface

The local operator interface of the M80-XP consists of a two line display menu and three buttons. The top line of the display menu is dedicated to reporting the current CH<sub>4</sub> concentration and the bottom line can be set to display and configure a variety of other values (See Section 4.21). The display menu is controlled using the three buttons.



**Figure 4.1: Display Menu Diagram**



To access the display, the display XP enclosure lid must be removed while the analyzer is powered on. Do so only when the area is known to be non-hazardous.

### 4.21 Adjustable Menu Values

Pressing the middle button will cycle the second line of the display to display various machine settings and outputs. To manually adjust a configurable menu item, follow the steps below:

- Step 1.** Verify that there are no explosive gases or other hazards present before proceeding.
- Step 2.** Loosen the set screw on the display XP enclosure lid using a 1/16 hex key.
- Step 3.** Remove the display XP enclosure lid to access the display.
- Step 4.** Press the center button repeatedly until the menu item in question appears on the second line of the display.
- Step 5.** Press the left or right menu buttons until the cursor is under the digit to be adjusted.
- Step 6.** Press the center button repeatedly until the desired value appears.
- Step 7.** Repeat Steps 5 and 6 until all digits have been set to the desired value.
- Step 8.** Press the right button repeatedly until the word “Saved” appears.
- Step 9.** Reinstall the display XP enclosure lid and secure with the set screw.



To cancel at any point and return to the starting set point, press the left button repeatedly until the word “Cancel” appears.

The table below is a standard list of the possible second line variables. A given system may have some or all of the available options based on customer specifications. The options available are set in the factory and can only be changed through the use of the factory GUI (See Section 4.3).

**Table 4.2 – Display Menu Outputs and Descriptions**

Output	Description
ppm CH <sub>4</sub> <sup>(1)</sup>	CH <sub>4</sub> Concentration in ppm
In Alarm Status <sup>(2)</sup>	Alarm Status of System
Alm H <sup>(2)</sup>	Alarm H Set Point <sup>(3)</sup>
Alm HH <sup>(2)</sup>	Alarm HH Set Point <sup>(3)</sup>
mV <sup>(2)</sup>	Raw Sensor mV Output
Zero <sup>(2)</sup>	Sensor Zero Offset <sup>(3)</sup>
Span <sup>(2)</sup>	Sensor Span Factor <sup>(3)</sup>
AO Span <sup>(2)</sup>	4 – 20 mA Output Span in % CH <sub>4</sub> <sup>(3)</sup>

(1) Found in the top line of the display menu

(2) Found in the second line of the display menu

(3) User configurable value

## 4.22 Alarm Set Points

There are two solid state outputs set at the factory prior to shipping. Alarm set points can be accessed through the analyzer’s display menu or through its factory calibration certificate. If the alarms need to be adjusted, follow the steps outlined in Section 4.21 for the alarm in question (Alm H or Alm HH).



Both alarms are normally open or de-energized (non-fail safe) and the hysteresis is set to 0.1.



When energized (in alarm state) in a DC powered unit the solid state outputs are equal to the power supply voltage. In an AC powered unit (120 – 240VAC) the solid state outputs will always be 12 VDC.

## 4.3 Software Interface (ICE M90-XP GUI)

The M80-XP is configured in the factory using a Windows based software and serial cable. This software is not normally required in the field unless the user needs to make a fundamental change to displayed units or retrieve archived data. At time of printing, the ICE GUI for the M80-XP is not shipped with the unit. If you require a copy, please contact Envent Engineering Ltd in order to have one forwarded to you. Copies can be forwarded either electronically or through the mail.



A serial to USB converter will be required to connect the system to most laptops.

## 4.4 Calibration Procedure

The number of calibrations required by the analyzer will depend on the application in question. It is recommended that a zero/span calibration is performed every 3 – 4 months (at minimum) to ensure accuracy and functionality. A zero/span calibration is performed at the factory prior to shipping.

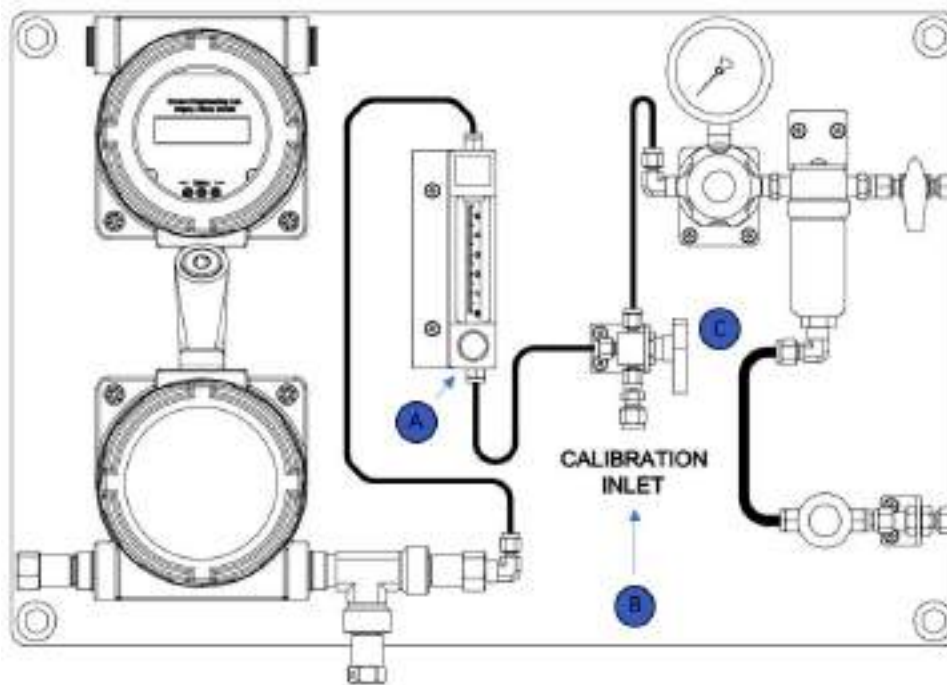


Incorrect configuration of the analyzer may cause errant operation. Injury to the operator and/or damage to the facilities may occur. The analyzer's functionality should be verified if any configuration changes have been made. Consult Envent Engineering Ltd.

When performing maintenance on the M80-XP the operator should carry a personal H<sub>2</sub>S monitor, wear a hard hat, hearing protection (if applicable), safety glasses, hand protection, and steel toed boots. Depending on the location, a breathing device may be required. Examples of such devices include SCBAs (Self-contained Breathing Apparatus) and SABAs (Supplied Air Breathing Apparatus).

All connections must be leak tight to ensure the safety of the user and the operation of the analyzer.

To access the display menu, the display XP enclosure lid must be removed while the analyzer is powered on. Do so only when the area is known to be non-hazardous.



**Figure 4.3: Calibration Reference Diagram**



To perform a zero/span calibration on the analyzer, please obey the following steps:

- Step 1.** Ensure that the field site bypass is enabled. No local bypass is available.
- Step 2.** Close off the flow meter (A)
- Step 3.** Connect a calibration gas bottle of 99.9% Nitrogen (N<sub>2</sub>) to the calibration inlet (B).
- Step 4.** Set the pressure of the calibration bottle to 15psi.
- Step 5.** Turn the 3-way valve (C) to switch from sample gas to calibration gas.
- Step 6.** Open the flow meter and set the flow to 200cc/min.
- Step 7.** Let the N<sub>2</sub> purge the sensor for 5 – 15 minutes.
- Step 8.** Loosen the set screw on the display XP enclosure lid with a 1/16 Hex key.
- Step 9.** Remove the display XP enclosure lid to gain access to the display.
- Step 10.** Press the center button repeatedly until Zero appears on screen.
- Step 11.** Press the left or right buttons until the cursor is under the digit to be adjusted.
- Step 12.** Press the center button repeatedly until the desired value appears.
- Step 13.** Repeat Steps 11 and 12 until all digits have been set to the desired value.
- Step 14.** Press the right button repeatedly until the word “Saved” appears.
- Step 15.** Continue to adjust Zero value until the CH<sub>4</sub> reading (top line of the display) is 1.00ppm.



Ensure that the CH<sub>4</sub> reading remains above 0.00.

- Step 16.** Close off the flow meter (A).
- Step 17.** Remove the calibration gas bottle of 99.9% Nitrogen from the calibration inlet (B).
- Step 18.** Connect a calibration bottle of CH<sub>4</sub> balanced in N<sub>2</sub> to the calibration inlet (B).
- Step 19.** Set the pressure of the calibration bottle to 15psi.
- Step 20.** Open the flow meter and set the flow to 200cc/min.
- Step 21.** Wait for the readings to stabilize. This can take up to 5 minutes.
- Step 22.** Press the center button repeatedly until Span appears on screen.
- Step 23.** Press the left or right buttons until the cursor is under the digit to be adjusted.
- Step 24.** Press the center button repeatedly until the desired value appears.
- Step 25.** Repeat Steps 23 and 24 until all digits have been set to the desired value.
- Step 26.** Press the right button repeatedly until the word “Saved” appears.
- Step 27.** Continue adjusting Span value until the CH<sub>4</sub> reading (top line of the display) is equal to the concentration indicated by the calibration bottle.
- Step 28.** Reinstall the display XP enclosure lid and secure with the set screw.
- Step 29.** Close off the flow meter (A).
- Step 30.** Remove the calibration gas bottle of CH<sub>4</sub> balanced in N<sub>2</sub> from the calibration inlet.
- Step 31.** Turn the 3-way valve (C) to switch from calibration gas to sample gas.
- Step 32.** Open the flow meter and set the flow to 200cc/min.
- Step 33.** Wait for the readings to stabilize (approximately 5 minutes).
- Step 34.** Disable the field site bypass.



To cancel at any point and return to the starting set point, press the left button repeatedly until the word “Cancel” appears.

## 5.0 Maintenance

---

The M80-XP was configured, functionally tested, and calibrated at the factory prior to shipping. All test and calibration data can be found in the Factory Calibration Report.

---



When performing maintenance on the M80-XP the operator should carry a personal H2S monitor, wear a hard hat, hearing protection (if applicable), safety glasses, hand protection, and steel toed boots. Depending on the location, a breathing device may be required. Examples of such devices include SCBAs (Self-contained Breathing Apparatus) and SABAs (Supplied Air Breathing Apparatus).

Do not disconnect equipment or open XP enclosures unless the power has been switched off or the area is known to be non-hazardous.

Field disassembly of any component of the analyzer or sample conditioning system is not advised. Consult the factory if disassembly is required.

Turn off the power before servicing. Ensure that the circuit breakers are off before connecting or disconnecting supply power.

No modifications or repairs to the flamepaths are permitted.

Substitution of components may impair flameproof safety and suitability for Class I, Division 1.

XP enclosures must have conduit plugs installed for unused conduit entries.

The XP enclosures' covers must remain installed and fully engaged to maintain area classification. They must be secured with the provided 6/32 x 1/2 set screw. A 1/16 hex key is required for removal.

All connections must be leak tight to ensure the safety of the user and the operation of the analyzer.

---

## 5.1 Monthly Check-Up

While the M80-XP requires little in the way of regular maintenance, a monthly check-up is still recommended to ensure that the system is performing to specifications. The recommended steps for a monthly check-up are as follows:

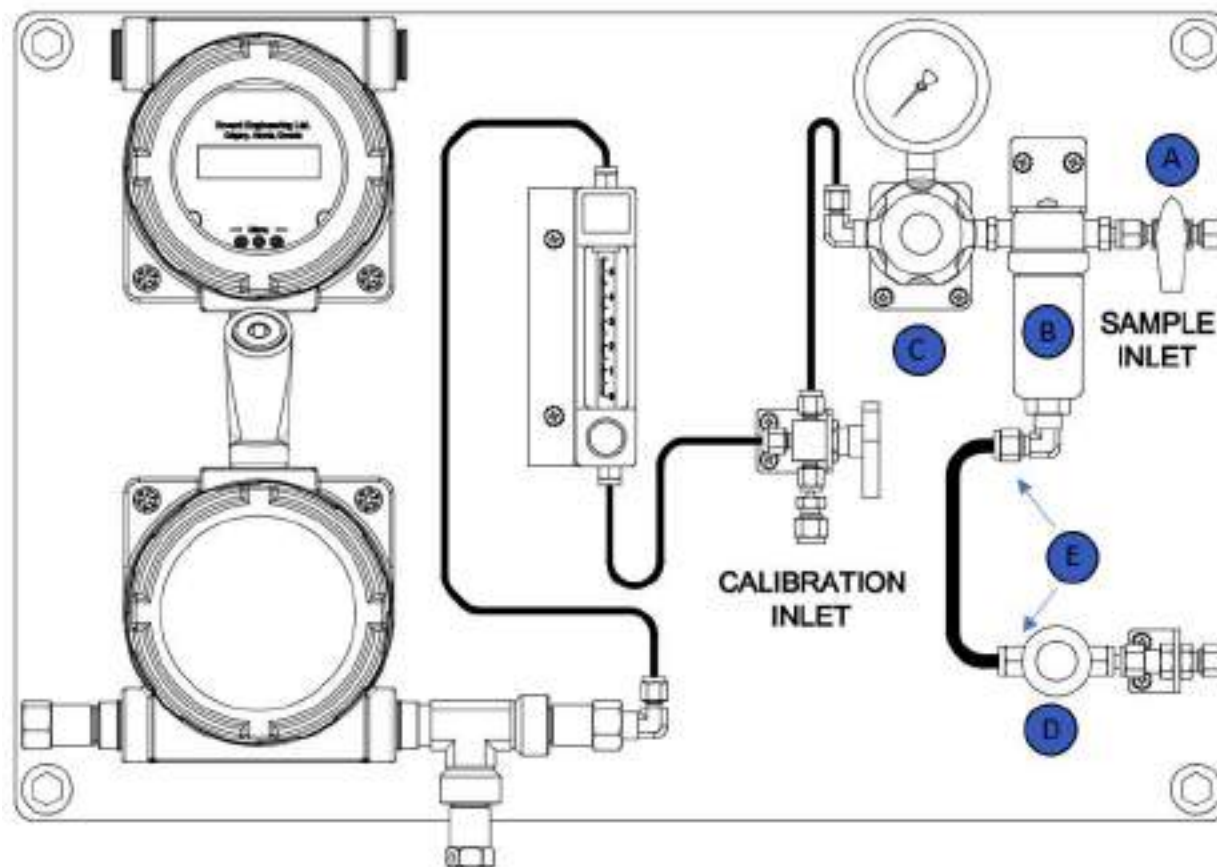
- Check that the analyzer's display is on and showing a CH<sub>4</sub> concentration.
- Check the sample inlet gas flow by inspecting the flow meter(s) and pressure gauge(s).
- Check the filter(s) in the sample conditioning system. Depending on the application and sample gas quality, the inlet filter will last between one and four months. Refer to Section 5.3 for the filter replacement procedure.
- It is recommended that a zero/span calibration is performed every 3 – 4 months (at minimum). Refer to Section 4.4 for the zero/span calibration procedure.

## 5.2 Spare Parts and Consumables

**Table 5.1 – Spare Parts and Consumables Summary**

Part Name	Part Number	Description
SCS Filters	330406	Box of 10 Filters, 12/19-57-50CSK
Flow Meter	100049	F65-193-SVA2/A-157-1-SAPP, Standard Flow Meter, F65-SVA2A4PMMXX
Electronic Stack	201001	Includes: Display Board and Mainboard AC/DC Converter (if applicable)
M90PPM-XP CH <sub>4</sub> Sensor	201502	Infrared Methane Gas Sensor 0-100%

## 5.3 Filter Replacement Procedure



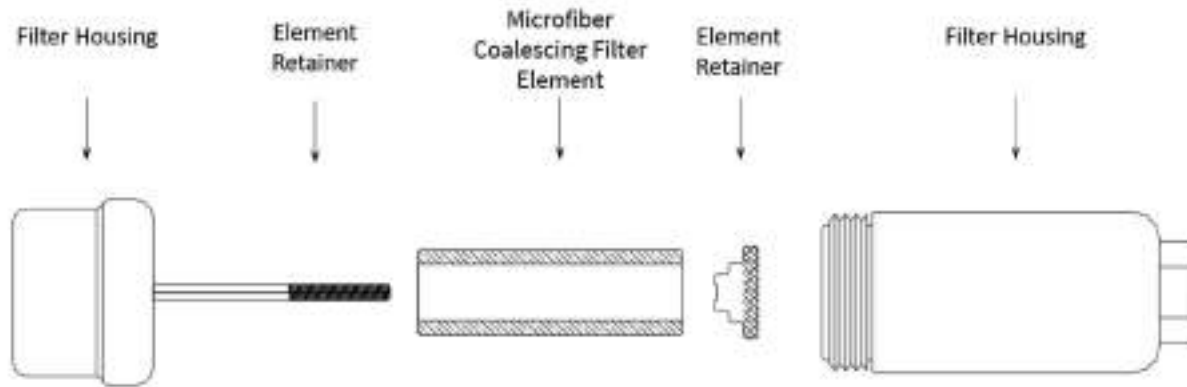
**Figure 5.2: Filter Replacement Reference Diagram**

- Step 1.** Ensure that the field site bypass is enabled. No local bypass is available on the analyzer.
- Step 2.** Shut off the sample gas inlet (A).
- Step 3.** Ensure there is no pressure in the filter housing by checking the pressure gauge. Open sample sweep needle valve (D) to release any remaining pressure.



Once the pressure has been released, close the sample sweep needle valve (D) to protect the operator from gas releases caused by backpressure from the sample sweep line.

- Step 4.** Dismantle the 1/4" tube piece by unscrewing both 1/4" nut fittings (E) using a 9/16" wrench.
- Step 5.** Remove the filter housing by using a 3/4" wrench. Go counterclockwise to loosen filter housing.
- Step 6.** Rotate the element retainer counterclockwise to gain access to the microfiber coalescing filter element.



**Figure 5.3: Microfibre Coalescing Filter Element Diagram**

- Step 7.** Discard the microfibre coalescing filter element and replace it with a new one. Refer to Section 5.2 for more information.
- Step 8.** Tighten the element retainer to between a quarter and a full turn after it first contacts the microfibre coalescing filter element. This will securely seal the filter tube. A mark on the end of the retainer can be used as a guide.
- Step 9.** Before replacing the filter housing ensure that the mating threads and sealing surfaces are clean and damage free. It is recommended that the threads and sealing faces be lubricated with a small amount of silicone grease before assembly. Stainless steel housings fitting contain a solid PTFE gasket.
- Step 10.** Install the filter housing back to its top base by using a torque wrench. It should be tightened to a torque of 30 – 40Nm.
- Step 11.** Reassemble the ¼” tube piece (E) using a 9/16” wrench.
- Step 12.** Open the sample gas inlet (A).
- Step 13.** Open the sample sweep needle valve (D) and adjust based on the desired CH<sub>4</sub> reading response time.
- Step 14.** Make sure that the pressure regulator is set to 15 psig.
- Step 15.** Make sure that the flow meter is set to 200cc/min.
- Step 16.** Wait 5 minutes for the analyzer's readings to stabilize.
- Step 17.** Disable the field site bypass.



All connections must be leak tight to ensure the safety of the user and the functionality of the analyzer.

## 5.4 Sensor Replacement Procedure

---



Incorrect configuration of the analyzer may cause errant operation. Injury to the operator and/or damage to the facilities may occur. The analyzer's functionality should be verified if any configuration changes have been made. Consult Envent Engineering Ltd for assistance.

When performing maintenance on the M80-XP the operator should carry a personal H2S monitor, wear a hard hat, hearing protection (if applicable), safety glasses, hand protection, and steel toed boots. Depending on the location, a breathing device may be required. Examples of such devices include SCBAs (Self-contained Breathing Apparatus) and SABAs (Supplied Air Breathing Apparatus).

All connections must be leak tight to ensure the safety of the user and the functionality of the analyzer.

To access the display, the XP enclosure lid must be removed while the analyzer is powered on. Ensure the area is known to be non-hazardous before proceeding.

---

The included CH<sub>4</sub> sensor is expected to last 3+ years (depending on the sample conditioning). As such, it is possible that the included CH<sub>4</sub> sensors will need to be replaced during the lifetime of the system.

It is recommended to contact Envent Engineering LTD to ensure that a sensor replacement is necessary.

Please perform the following steps to complete the sensor replacement:

- Step 1.** Disconnect the power to the analyzer.
- Step 2.** Shut off the sample gas inlet to isolate the analyzer.
- Step 3.** Ensure there is no remaining sample gas in the sample conditioning system.
- Step 4.** Loosen the set screw on the sensor XP enclosure lid with a 1/16 Hex key.
- Step 5.** Remove the sensor XP enclosure lid to gain access to the CH<sub>4</sub> sensor.
- Step 6.** Remove CH<sub>4</sub> sensor mounting screws.
- Step 7.** Unplug the wiring connector from the CH<sub>4</sub> sensor.
- Step 8.** Disconnect the 1/8" PFA tubing from the CH<sub>4</sub> sensor's tubing fittings
- Step 9.** Take the new CH<sub>4</sub> sensor and connect the 1/8" inlet and outlet PFA tubing to the CH<sub>4</sub> sensor's tubing fittings.



The inlet and outlet tubing fittings are not interchangeable and are labeled as "In" and "Out" respectively.

- Step 10.** Reinstall the sensor XP enclosure lid and secure with the set screw.
- Step 11.** Reconnect the power to the analyzer.

- Step 12.** Open the sample gas inlet.
- Step 13.** Wait approximately 5 minutes.
- Step 14.** Calibrate the new CH<sub>4</sub> sensor. Refer to Section 4.4 for the calibration procedure.



All connections must be leak tight to ensure the safety of the user and the functionality of the analyzer.



The new calibration factors should be recorded for future reference.

## 5.5 Sample Conditioning System Cleaning Procedure

During start-up or plant upset situations, the analyzer and sample conditioning system may become contaminated with amine or a hydrogen sulfide scavenger solution. This in turn may cause the analyzer to read incorrectly. The scavenger solution is water soluble and therefore is relatively easy to clean. Should it become necessary to clean the sample conditioning system and the CH<sub>4</sub> sensor, follow the steps below.



If the analyzer requires cleaning on a regular basis, the sample point may have to be relocated or additional sample conditioning may be required. Please consult Envent Engineering Ltd.



**Electrostatic Hazard – The aluminum backpan and blue polyester powder coated XP enclosures must be cleaned exclusively with a damp cloth to prevent a static charging hazard.**

**Do not use solvents, brake cleaners, soaps, detergents, or rubbing alcohol to clean the analyzer or the sample conditioning system.**

The materials required to clean the sample conditioning system are:

- A residue free cleaning agent (such as Alconox Laboratory Cleaner)
- Clean fresh water
- 100% isopropyl alcohol
- A rinse bottle

**Step 1.** Mix the residue cleaning agent and warm water to produce a cleaning solution. The solution should have a concentration of approximately 1% (2.5tbsp/gal).

**Step 2.** Shut off the sample flow at the sample point prior to the sample system.



The sweep valve on the sample filter should be left slightly open at all times. This will decrease the likelihood of contamination.

**Step 3.** Disassemble the sample conditioning system components and tubing.



It is recommended to take pictures before disassembling the components of the sample conditioning system as this will aid in reassembly. Alternatively, refer to the provided customer drawing package

**Step 4.** Throw away the microfibre coalescing filter element.



**Step 5.** Place all disassembled components in a bucket and add the cleaning solution prepared in Step 1. The required soaking time required will depend on how contaminated the components are. Ensure that the components and tubing are clean before proceeding to the next step.



Ensure that all valves are completely open when cleaning. 3-way valves should be cleaned with the handle in all possible positions

**Step 6.** Rinse the components with fresh water.

**Step 7.** Flush the tubing and components with isopropyl alcohol.

**Step 8.** Dry the tubing and components with clean instrument air.

**Step 9.** Re-assemble the sample conditioning system and replace the microfiber coalescing filter element according to the customer drawing package or pictures taken prior to disassembly.



Refer to Section 5.3 for more detailed instructions when installing the new microfibre coalescing filter element into the filter housing.

**Step 10.** To clean the CH<sub>4</sub> sensor, rinse the input and output entries of the sensor with isopropyl alcohol.

**Step 11.** If any of the PFA tubing appears discolored, replace it with new tubing.

**Step 12.** Recalibrate the analyzer. Refer to Section 4.4 for the calibration procedure.

## 6.0 Troubleshooting

Symptom	Possible Causes	Recommended Solutions
Lower than expected CH <sub>4</sub> readings and/or slow readings	Leak in sensor	Check for leaks and seal as needed.
	Insufficient sample flow rate	Ensure that the flow rate is appropriate for the analyzer in question. See Section 2.3 for the recommended values.
	Contaminant or liquid carry over in SCS	Refer to Section 5.5 for the sample conditioning system cleaning procedure.
	Blocked sample vent line	Check for blocks and clear as needed.
	Closed sweep valve	Adjust the sweep valve to a level where the analyzer response time increases to the desired rate.
	Incorrect power terminal settings	Check for 24 VDC (18 – 30 V) on the power terminals.
	Faulty CH <sub>4</sub> sensor	Replace the entire sensor. See Section 5.4 for the sensor replacement procedure.
Erratic CH <sub>4</sub> readings	Changing flow rate due to a faulty regulator	A replacement regulator is required. Contact Envent Engineering Ltd.
Higher than expected CH <sub>4</sub> readings	Gain is set too high	Re-calibrate analyzer and refer to factory gain. The difference between factory gain and new gain should be no more than $\pm 2\%$ . If necessary, perform a gas calibration. Refer to Section 4.4 for the calibration procedure.
	Excessive sample flow rate	Ensure that the flow rate is appropriate for the analyzer in question. See Section 2.3 for the recommended values.
Analyzer not turning on	Blown fuse	A replacement Mainboard and/or AC-DC converter is required. Contact Envent Engineering Ltd.
	Inappropriate voltage rating	Refer to the ETL Certification Nameplate on the analyzer or the Factory Calibration Certificate for more information on the analyzer voltage rating
	Mainboard malfunction	A replacement Mainboard is required. Contact Envent Engineering Ltd.
Analog outputs (4-20 mA) not working	Improper wiring	Verify wiring. Refer to Section 3.4 for more information.
	System variable for the AO output has been modified	Analog output 4-20mA is configured based on the CH <sub>4</sub> range. Refer to Section 4.2 for more information on how to change set points.
Pressure gauge not working	Pressure gauge has been overpressurized	A replacement pressure gauge is required. Contact Envent Engineering Ltd.

# Appendix A – Standard Modbus Register Map

---

**Table A1 – Modbus Output Status (Coils)**

Registry Number	Data Field
(0)	Relay 1
(2)	Relay 1
(4)	Relay 2
(6)	Relay 2

**Table A2 – Modbus Output Registry Numbers**

Data Field	32 Bit Integers
% CH <sub>4</sub>	(40001)
ppm CH <sub>4</sub>	(40003)
mV	(40005)

# Appendix B – Risk Assessment

**Table B1 – Risk Assessment Matrix**

	Severity of Impact and/or Consequences					
		Negligible	Minor	Moderate	Serious	Critical
Likelihood Of Event	Very Likely	Medium	Medium	High	High	High
	Likely	Low	Medium	High	High	High
	Possible	Low	Low	Medium	High	High
	Unlikely	Low	Low	Low	Medium	High
	Very Unlikely	Low	Low	Low	Medium	Medium

**Table B2 – Situational Risk Assessment**

Hazardous Situation	At Risk Personnel	Safety Hazards	Initial Risk Assessment	Residual Risk Assessment
Changing filter in SCS	Operator(s)	The release of high pressure gases can cause serious injuries	Possible – Serious (High)	Very Unlikely – Serious (Medium)
The filter is located before the pressure regulator. As such, pressures up to 3600PSI can be present. The operator must isolate the sample system before changing the filter.				
Leakage or rupture due to high pressure	Operator(s)	The release of high pressure gases can cause serious injuries	Unlikely – Serious (High)	Very Unlikely – Serious (Medium)
Depending on the sample conditioning system, the inlet maximum pressure varies. Please consult document package for the maximum pressure for the sample system. Do not apply more pressure than specified as this can cause damage to the analyzer and create safety risks.				
H2S Exposure (Atmosphere)	Operator(s)	H2S exposure is a potentially lethal health/safety risk. Consult Table B4 for more information.	Unlikely – Serious (Medium)	Very Unlikely – Serious (Medium)
For atmospheres where there is H2S, depending on the levels and company policy, the operator must wear the appropriate equipment before servicing an M-Series analyzer				

<b>Hazardous Situation</b>	<b>At Risk Personnel</b>	<b>Safety Hazards</b>	<b>Initial Risk Assessment</b>	<b>Residual Risk Assessment</b>
H2S Exposure (Leakage / Overpressure)	Operator(s)	H2S exposure is a potentially lethal health/safety risk. Consult Table B4 for more information.	Unlikely – Critical (High)	Very Unlikely – Critical (Medium)
In case of leakage, follow the company's health and safety policies on how to deal with an H2S leak. Depending on the application and location of the M-Series analyzer, the operator might require breathing equipment.				
Exposure to other gases	Operator(s)	Potentially lethal health/safety risk. Explosion, O <sub>2</sub> deprivation	Unlikely – Critical (High)	Very Unlikely – Critical (Medium)
In case of a leak, follow the company's health and safety policies on how to deal with gas leak. Depending on the application and location of the M-Series analyzer, the operator might require breathing equipment.				
Flooding the sample system and analyzer	Operator(s)	No immediate health/safety concern	Possible – Minor (Low)	Unlikely – Minor (Low)
If the analyzer is flooded, the analyzer needs to be immediately isolated, turned off, and cleaned.				
Voltage hazards	Operator(s)	Immediate health/safety risk.	Unlikely – Serious (Medium)	Very Unlikely – Serious (Medium)
It is important that the operator is trained on handling the analyzer when it is on. The analyzer does not need to be off when it goes into maintenance. However, it is very important that the operator is aware of the danger of an electric shock				
Electrostatic hazard - explosion hazard	Operator(s)	Immediate health/safety risk.	Unlikely – Critical (High)	Very Unlikely – Critical (Medium)
The backpan and certification nameplate may be cleaned only with a damp cloth to prevent static charging hazards which could result in an explosion.				
Analyzer weight	Operator(s)	Body Injury	Unlikely – Moderate (Low)	Very Unlikely – Moderate (Low)
In some cases, unpacking and transporting the analyzer will require a minimum of two persons.				
Re-configuring the configuration file. Physical configuration of the analyzer and/or sample conditioning system	Operator(s)	Potential safety risk	Unlikely – Serious (Medium)	Unlikely – Serious (Medium)
Do not physically modify the M-Series analyzer or sample conditioning system as this voids the hazardous location certification. Software configuration should not be changed by the user.				

**Table B3 – Physical Properties of Hydrogen Sulfide (H<sub>2</sub>S)**

Physical State	- Gaseous above -60°C
Appearance	- Invisible
Odor	- Smell of rotten eggs at 0.5ppb - Olfactory paralysis at ~100ppm
Vapor Density	- Heavier than air (relative density of 1.19 compared to air) - In gas mixtures, it will be present wherever the gas mixture is found - Gas mixtures may be heavier or lighter than air, depending upon their vapor density and temperature compared to the ambient atmosphere (i.e. usually air) - In its pure state, or as a high proportion of a gas mixture, it may flow or settle into low-lying areas, such as pits, trenches and natural depressions
Flammability	- Flammable at 4.3% – 46% vapor concentration in air, by volume - Burns with a blue flame and creates gaseous sulphur dioxide (SO <sub>2</sub> ). SO <sub>2</sub> can irritate the eyes and respiratory system
Solubility	- Soluble in water and oil - Solubility of ~4g/L in water @ 20°C - Solubility is inversely proportional to fluid temperature
Common Locations for H <sub>2</sub> S	- Piping systems, pipelines, wellheads or wellbores, vessels, production facilities, tanks, pits and low spots, confined or enclosure spaces, shacks or buildings, bermed or diked area, sour spills.

**Table B4 – Health Effects of Hydrogen Sulfide (H<sub>2</sub>S) at Varying concentrations**

H <sub>2</sub> S Concentration	Possible Health Effects
<1ppm	- No known health effects - Can be smelled
1ppm – 10ppm	- No known health effects - Up to 10ppm the exposure limit is 8 hours*
10ppm – 15ppm	- Up to 15ppm the exposure limit is 15 minutes between 60 minute breaks*
20ppm – 200ppm	- Eye and respiratory tract irritation and loss of smell - Headache and nausea - loss of smell after 2 - 5 min - Respiratory protection is required beyond this level
200ppm – 500ppm	- Above effects, but sooner and more severe - Loss of breathing and death in 30 min to 1 hour
500ppm – 700ppm	- Affects the central nervous system - Rapid unconsciousness, cessation of breathing, and death
>700ppm	- Immediate loss of consciousness - Permanent brain damage and death in a few minutes even if removed to fresh air at once

\*Check local legislations as these values may vary between locations

# Appendix C – Certifications



## AUTHORIZATION TO MARK

This authorizes the application of the Certification Mark(s) shown below to the models described in the Product(s) Covered section when made in accordance with the conditions set forth in the Certification Agreement and Listing Report. This authorization also applies to multiple listee model(s) identified on the correlation page of the Listing Report.

This document is the property of Intertek Testing Services and is not transferable. The certification mark(s) may be applied only at the location of the Party Authorized To Apply Mark.

<b>Applicant:</b>	Envent Engineering Ltd 2721 Hopewell Place NE	<b>Manufacturer:</b>	Envent Engineering Ltd 2721 Hopewell Place NE
<b>Address:</b>	Calgary, AB T1Y 7J7	<b>Address:</b>	Calgary, AB T1Y 7J7
<b>Country:</b>	Canada	<b>Country:</b>	Canada
<b>Contact:</b>	Mr. Gabriel Noguera	<b>Contact:</b>	Mr. Gabriel Noguera
<b>Phone:</b>	(403) 253-4012	<b>Phone:</b>	(403) 253-4012
<b>FAX:</b>	(403) 253-4016	<b>FAX:</b>	(403) 253-4016
<b>Email:</b>	gnoguera@envent-eng.com	<b>Email:</b>	gnoguera@envent-eng.com

**Party Authorized To Apply Mark:** Same as Manufacturer  
**Report Issuing Office:** Edmonton, AB Canada

**Control Number:** 4002458

**Authorized by:** \_\_\_\_\_

*Matthew Snyder*  
for L. Matthew Snyder, Certification Manager



This document supersedes all previous Authorizations to Mark for the noted Report Number.

This Authorization to Mark is for the exclusive use of Intertek's Client and is provided pursuant to the Certification agreement between Intertek and its Client. Intertek's responsibility and liability are limited to the terms and conditions of the agreement. Intertek assumes no liability to any party, other than to the Client in accordance with the agreement, for any loss, expense or damage occasioned by the use of this Authorization to Mark. Only the Client is authorized to permit copying or distribution of this Authorization to Mark and then only in its entirety. Use of Intertek's Certification mark is restricted to the conditions laid out in the agreement and in this Authorization to Mark. Any further use of the Intertek name for the sale or advertisement of the tested material, product or service must first be approved in writing by Intertek. Initial Factory Assessments and Follow up Services are for the purpose of assuring appropriate usage of the Certification mark in accordance with the agreement, they are not for the purposes of production quality control and do not relieve the Client of their obligations in this respect.

Intertek Testing Services NA Inc.  
 545 East Algonquin Road, Arlington Heights, IL 60005  
 Telephone 800-345-3851 or 847-439-5667 Fax 312-283-1672

**Standard(s):**

- Safety Requirements For Electrical Equipment For Measurement, Control, And Laboratory Use - Part 1: General Requirements [UL 61010-1:2012 Ed.3]
- Safety Requirements For Electrical Equipment For Measurement, Control, And Laboratory Use Part 1: General Requirements [CSA C22.2#61010-1-12:2012 Ed.3]
- Explosion-Proof And Dust-Ignition-Proof Electrical Equipment For Use In Hazardous (Classified) Locations [UL 1203:2013 Ed.5+R:16Apr2019]
- Explosion-Proof Enclosures For Use In Class I Hazardous Locations (R2016) [CSA C22.2#30:1986 Ed.3+G1;G2]

<b>Product:</b>	M series gas monitors: For use in: Class I Division 1 Groups C & D, indoor use T Code: T3 Tamb: 0°C to 50°C Maximum input pressure for M60-XP, M70-XP and M90-XP: 15 psig, relieved at 25 psig Maximum input flow: 100-500 cc/min at 15 psig Maximum input pressure for M90PPM-XP: 12 psig to 15psig. Maximum input pressure for M80-XP: 12 psig to 15psig.
<b>Models:</b>	M60-XP, M70-XP, M90-XP, M90PPM-XP, M80-XP




# Appendix D – Sealing Compound Information

KILLARK FITTINGS


EY SERIES

KILLARK


### SEALING FITTINGS




**EY**  
(For Vertical or Horizontal Conduit)




**EYS**  
(For Vertical or Horizontal Conduit)



**EY**  
(For Vertical Conduit)



**EYD**  
(Gasket Seal for Vertical Conduit)



**ERY-2**  
(Fixture Hanger)  
(See Page L146)

**Class I, Div. 1 & 2, Groups A, B, C, D**  
**Class I, Zone 1, Groups IC, IIC, IIA**  
**Class II, Div. 1 & 2, Groups E, F, G**  
**Class III**

**FEATURES-SPECIFICATIONS**

**Application & Installation**  
**Class I, Divisions 1 and 2**

The purpose of seals in a Class I hazardous location is to minimize the passage of gases and vapors and prevent the passage of flames from one electrical installation to another through the conduit system. Seals are required to be installed within 18 inches on any conduit run entering an enclosure which contains devices that may produce arcs, sparks, or high temperature. Where two enclosures are connected by a run of conduit not over 3 ft. long, a single seal located at the center of the run is considered satisfactory. Only explosionproof unions, couplings, elbows, and conduit bodies similar to "L," "T," and "X" type shall be permitted between the sealing fitting and the enclosure.

Seals shall be located within 18 inches of the enclosure or fitting on each conduit run of 2 inch size or larger entering an enclosure or fitting that contains terminals, splices, or taps.

Each run of conduit from a hazardous location to a nonhazardous location should be sealed to minimize the amount of gases and vapors communicated beyond the seal.

**Class II, Divisions 1 and 2**

Where a raceway provides communication between an enclosure which is required to be dust-ignitionproof and one which is not, suitable means shall be provided to prevent the entrance of dust into the dust-ignitionproof enclosure through the raceway.

**Consideration for selection seals:**

Select the proper sealing fitting for the hazardous gas/vapor involved: (i.e., Class I Groups A, B, C, or D; Zone 1, Groups IC, IIC, IIA, IC).

Select a sealing fitting for the proper use in respect to mounting position. This is particularly critical when the conduit runs between hazardous and nonhazardous areas. Some seals are designed to be mounted in any position; others are restricted to vertical mounting.

**Drains**

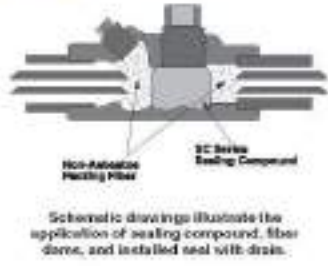
Where there is a probability that liquid or other condensed vapor may be trapped within enclosures for control equipment or at any point in the raceway system, approved means – such as installation of drain seals – shall be provided to prevent moisture accumulation.

For more complete data or special applications, consult the code or your local inspector.

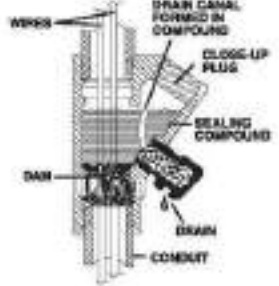
Sealing compounds shall be approved for the purpose and shall not be affected by the surrounding atmosphere or liquids, and shall not have a melting point of less than 93°C. (200°F).

In the complete seal, the minimum thickness of the sealing compound shall not be less than the trade size of the conduit, and in no case less than 5/8 inch.

NOTE: The amount of Killark sealing compound and packing fiber required for any seal is determined by volume, hole size, and mounting position of the seal. Refer to installation data table on page F00 for specific amounts required.



Schematic drawings illustrate the application of sealing compound, fiber dome, and installed seal with drain.



Labels in diagram: WIRE, DRAIN CANAL FORMED IN COMPOUND, BLOCK-UP PLUG, SEALING COMPOUND, DRAIN, CONDUIT.

Splices and taps shall not be made in fittings intended only for sealing with compound, nor shall other fittings in which splices or taps are made be filled with compound.

Killark sealing fittings are produced with utmost care to insure a substantial margin of safety. Threads are clean, deep, and snag. Wires properly installed with Killark sealing compound (SO Type) and Killark non-asbestos fiber (PF Type) for the drains, you can be sure your installation will provide more than adequate safety.

KILLARK

WWW.HUBBELL-KILLARK.COM

HUBBELL  
POWER & TECHNOLOGY

# FITTINGS

ENY/EYS SERIES



## SEALING FITTINGS



**ENY-1, 2, 3, 4, 5, 6**  
 Class I, Div. 1 & 2, Groups A, B, C, D  
 Class I, Zone 1, Groups IC, IIB, IIA  
 Class II, Div. 1 & 2, Groups E, F, G  
 Class III

**EYS Series**  
 Class I, Div. 1 & 2, Group C, D  
 Class I, Zone 1, Groups IC, IIA  
 Class II, Div. 1 & 2, Groups E, F, G  
 Class III

File No. 315514  
 Certified File No. LR11710  
 See files for details on our ENEC

### FEATURES-SPECIFICATIONS

Material/Finish

**Copper-free Aluminum**  
 (less than 4/10 of 1%)

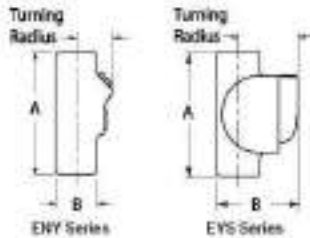
- Electrostatically applied powder coating

**Duralloy Iron**

- Ti-Coat Finish of electrocure, chromate sealant, and electrostatically applied powder coating

NIPPLE SIZE	ENY SEALING FITTINGS				TURNING RADIUS	ENY WITH NIPPLE	
	KILLARK ALUMINUM	DURALLOY IRON	A	B		KILLARK ALUMINUM	DURALLOY IRON
1/2"	ENY-1	ENY-1R	4.130" (105)	1.893" (48)	1.800" (46)	ENY-1-T	ENY-1TR
3/4"	ENY-2	ENY-2R	4.510" (115)	1.92" (49)	1.800" (46)	ENY-2-T	ENY-2TR
1"	ENY-3	ENY-3R	5" (127)	1.94" (49)	1.800" (46)	ENY-3-T	ENY-3TR
1-1/4"	ENY-4	ENY-4R	5.380" (137)	2.010" (51)	1.800" (46)	ENY-4-T	ENY-4TR
1-1/2"	ENY-5	ENY-5R	5.760" (146)	2.080" (53)	1.800" (46)	ENY-5-T	ENY-5TR
2"	ENY-6	ENY-6R	6.380" (163)	2.180" (55)	2.000" (51)	ENY-6-T	ENY-6TR

### Dimensions



NIPPLE SIZE	EYS SEALING FITTINGS				TURNING RADIUS	EYS WITH NIPPLE	
	KILLARK ALUMINUM	DURALLOY IRON	A	B		KILLARK ALUMINUM	DURALLOY IRON
1/2"	EYS-1	—	2.810" (71)	1.010" (26)	1.000" (25)	EYS-1-T	—
3/4"	EYS-2	—	4.100" (104)	2.100" (53)	1.800" (46)	EYS-2-T	—
1"	EYS-3	—	4.280" (109)	2.100" (53)	1.800" (46)	EYS-3-T	—
1-1/4"	EYS-4	—	4.380" (111)	2.200" (56)	1.800" (46)	EYS-4-T	—
1-1/2"	EYS-5	—	5.100" (130)	2.300" (58)	1.800" (46)	EYS-5-T	—
2"	EYS-6	—	6.380" (163)	2.100" (53)	2.000" (51)	EYS-6-T	—
2-1/2"	EYS-7	EYS-7R	7.880" (200)	4.100" (104)	4.100" (104)	EYS-7-T	EYS-7TR
3"	EYS-8	EYS-8R	7.980" (202)	4.100" (104)	4.300" (110)	EYS-8-T	EYS-8TR
3-1/2"	EYS-9	EYS-9R	7.100" (180)	5.000" (127)	4.300" (110)	EYS-9-T	EYS-9TR
4"	EYS-8	EYS-8R	7.100" (180)	5.000" (127)	4.300" (110)	EYS-8-T	EYS-8TR



# KILLARK

## SEALING FITTING



**EY & EYD Series**  
 Class I, Div. 1 & 2, Groups C, D  
 Class I, Zone 1, Groups IIB, IIA  
 Class II, Div. 1 & 2, Groups E, F, G  
 Class III

File No. 210514  
 Certified File No. LB11716  
 See Hubs for details or call Killark.

### FEATURES-SPECIFICATIONS

#### Material/Finish

**Copper-free Aluminum**  
 (less than 4/10 of 1%)

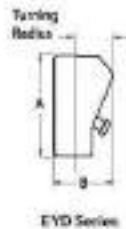
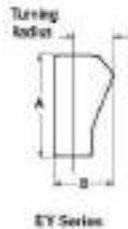
- Electrostatically applied powder coating

#### Duraloy Iron

- Tri-Coat Finish of electrocoat, chromate sealant, and electrostatically applied powder coating

HUB SIZE	EY SEALING FITTINGS				TURNING RADIUS	EY WITH NIPPLE	
	CATALOG NUMBER		DIMENSIONS			CATALOG NUMBER	
	KILLARK ALUMINUM	DURALOY IRON	A	B		KILLARK ALUMINUM	DURALOY IRON
1/2"	EY-1	EY-1M	3.415(28)	2.34(23)	1.14(37)	EY-1-T	EY-1TM
3/4"	EY-2	EY-2M	3.135(26)	2.34(23)	1.14(37)	EY-2-T	EY-2TM
1"	EY-3	EY-3M	4.632(185)	3.18(26)	3.31(26)	EY-3-T	EY-3TM
1-1/8"	EY-4	EY-4M	5.31(28)	3.28(28)	3.69(28)	EY-4-T	EY-4TM
1-1/2"	EY-5	EY-5M	5.58(28)	4.58(31.5)	3.04(30)	EY-5-T	EY-5TM
2"	EY-6	EY-6M	5.18(232)	5.11(214)	4.14(23)	EY-6-T	EY-6TM
3-1/2"	EY-7	EY-7M	7(170)	6.5(213)	4.6(115)	EY-7-T	EY-7TM
3"	EY-8	EY-8M	7(170)	5.5(213)	4.6(115)	EY-8-T	EY-8TM
3-1/2"	EY-9	EY-9M	6.34(222)	7.1(218)	5.5(213)	EY-9-T	EY-9TM
4"	EY-8	EY-8M	6.34(222)	7.1(218)	5.5(213)	EY-9-T	EY-8TM

### Dimensions



HUB SIZE	EYD SEALING FITTINGS				TURNING RADIUS	EYD WITH NIPPLE		
	CATALOG NUMBER		DIMENSIONS			CATALOG NUMBER		
	KILLARK ALUMINUM	DURALOY IRON	A	B		KILLARK ALUMINUM	DURALOY IRON	
1/2"	See Note 1/2", 3/4", 1" Drain Seal offering on page 100							
3/4"								
1"								
1-1/8"	EYD-4	EYD-4M	5.31(28)	3.28(28)	3.69(28)	EYD-4-T	EYD-4TM	
1-1/2"	EYD-5	EYD-5M	5.58(28)	4.58(31.5)	3.04(30)	EYD-5-T	EYD-5TM	
2"	EYD-6	EYD-6M	5.18(232)	5.11(214)	4.14(23)	EYD-6-T	EYD-6TM	
3-1/2"	EYD-7	EYD-7M	7(170)	6.5(213)	4.6(115)	EYD-7-T	EYD-7TM	
3"	EYD-8	EYD-8M	7(170)	5.5(213)	4.6(115)	EYD-8-T	EYD-8TM	
3-1/2"	EYD-9	EYD-9M	6.34(222)	7.1(218)	5.5(213)	EYD-9-T	EYD-9TM	
4"	EYD-8	EYD-8M	6.34(222)	7.1(218)	5.5(213)	EYD-9-T	EYD-8TM	

# FITTINGS

EY SERIES



## 25% FILL VERTICAL SEALING FITTINGS



EY-75M



EY-75TM

**EY Series**  
 Class I, Div. 1 & 2, Groups B, C, D  
 Class I, Zone 1, Groups 9B, 9A  
 Class II, Div. 1 & 2, Groups E, F, G  
 Class III



### FEATURES-SPECIFICATIONS

#### Applications

To seal conduits in vertical runs. To minimize the passage of gases and vapors and prevent the passage of flames from one portion of the electrical system to another through the conduit.

#### Features

- Large opening for easy packing of fiber dam and pouring of compound
- Integral bushings in conduit hubs to protect conductor insulation from damage
- Not-tapped hubs to ensure ground continuity
- Design provides minimum turning radius
- 25% conductor fill
- EY-T styles supplied with removable close nipples

#### Material/Finish

**Copper-free Aluminum**  
 (less than 4/10 of 1%)

- Electrostatically applied powder coating

#### Duraloy Iron

- Tri-Coat Finish of electrocoat, chromate sealant, and electrostatically applied powder coating

EY VERTICAL SEALING FITTINGS						
HUB SIZE	CATALOG NUMBER	DIMENSIONS		TURNING RADIUS*	SEALING COMPOUND REQUIRED	PER HUB (PF)
	KILLARK ALIUMNUM	A	B			
1/2"	EY-50	3-5/16" (94)	1-4/8" (33)	5-11/16" (37)	3/4 oz.	1/32 sq.
3/4"	EY-75	3-11/16" (94)	1-5/16" (33)	2" (51)	1-3/4 oz.	1/16 sq.
1"	EY-100	4-5/8" (111)	1-3/8" (41)	3-7/16" (52)	3-3/4 oz.	1/8 sq.

\*Turning radius with plug removed.

EY VERTICAL SEALING FITTINGS WITH NIPPLE						
HUB SIZE	CATALOG NUMBER	DIMENSIONS		TURNING RADIUS*	SEALING COMPOUND REQUIRED	PER HUB (PF)
	KILLARK ALIUMNUM	A	B			
1/2"	EY-50-T	4-3/16" (106)	1-4/8" (33)	5-11/16" (37)	3/4 oz.	1/32 sq.
3/4"	EY-75-T	4-9/16" (116)	1-5/16" (33)	2" (51)	1-3/4 oz.	1/16 sq.
1"	EY-100-T	5-1/2" (140)	1-3/8" (41)	3-7/16" (52)	3-3/4 oz.	1/8 sq.

\*Turning radius with plug removed.

EY VERTICAL SEALING FITTINGS						
HUB SIZE	CATALOG NUMBER	DIMENSIONS		TURNING RADIUS*	SEALING COMPOUND REQUIRED	PER HUB (PF)
	KILLARK IRON	A	B			
1/2"	EY-50M	3-5/16" (94)	1-4/8" (33)	5-11/16" (37)	3/4 oz.	1/32 sq.
3/4"	EY-75M	3-11/16" (94)	1-5/16" (33)	2" (51)	1-3/4 oz.	1/16 sq.
1"	EY-100M	4-5/8" (111)	1-3/8" (41)	3-7/16" (52)	3-3/4 oz.	1/8 sq.

\*Turning radius with plug removed.

EY VERTICAL SEALING FITTINGS WITH NIPPLE						
HUB SIZE	CATALOG NUMBER	DIMENSIONS		TURNING RADIUS*	SEALING COMPOUND REQUIRED	PER HUB (PF)
	KILLARK IRON	A	B			
1/2"	EY-50TM	4-3/16" (106)	1-4/8" (33)	5-11/16" (37)	3/4 oz.	1/32 sq.
3/4"	EY-75TM	4-9/16" (116)	1-5/16" (33)	2" (51)	1-3/4 oz.	1/16 sq.
1"	EY-100TM	5-1/2" (140)	1-3/8" (41)	3-7/16" (52)	3-3/4 oz.	1/8 sq.

\*Turning radius with plug removed.





## DRAIN SEALING FITTING



EYD-75M

EYD-75TM

Class I, Div. 1 & 2, Groups B, C, D  
 Class I, Zone 1, Groups II-B, II-A  
 Class II, Div. 1 & 2, Groups E, F, G  
 Class III



### FEATURES-SPECIFICATIONS

#### Applications

To seal and drain vertical conduits. To minimize the passage of gases and vapors and prevent the passage of flames from one portion of the electrical system to another through the conduit.

#### Features

- Threaded for Rigid Conduit or IMC
- Tapered threads (NPT)
- Simple to install. Internal drainage path provides a visual means to ensure that the compound chamber is properly filled. No need to use bases and wires
- Large cover openings for easy packing of fiber dam on 1/2" through 1" sizes
- Temporary plastic sleeve protects thread for drain/breather from contamination when pouring compound
- Unique design enables installation of drain/breather right after compound is poured – no waiting
- Provides continuous water drain path while allowing conduit run to breathe, in compliance with the NEC
- Includes Drain Breather Fitting KDB-375

#### Material/Finish

**Copper-free Aluminum**  
 (less than 4/10 of 1%)

- Electrostatically applied powder coating

#### Duralloy Iron

- Tri-Coat Finish of electro-zinc, chromate sealant, and electro-statically applied powder coating

HUB SIZE	CATALOG NUMBER		DIMENSIONS		TURNING RADIUS*	SEALING COMPOUND REQUIRED	PER HUB (FF)
	KILLARK ALUMINUM		A	B			
1/2"	EYD-58		3-1/2"(89)	1-1/8"(29)	1-5/8"(41)	1-1/4 oz.	1/22 oz.
3/4"	EYD-75		3-3/4"(95)	1-3/8"(35)	1-5/4"(45)	2 oz.	1/16 oz.
1"	EYD-90		4-3/8"(115)	1-3/4"(45)	2-1/8"(54)	4 oz.	1/8 oz.

\*Turning radius with plug removed.

HUB SIZE	CATALOG NUMBER		DIMENSIONS		TURNING RADIUS*	SEALING COMPOUND REQUIRED	PER HUB (FF)
	KILLARK ALUMINUM		A	B			
1/2"	EYD-58T		4-3/8"(115)	1-1/8"(29)	1-5/8"(41)	1-1/4 oz.	1/22 oz.
3/4"	EYD-75T		4-5/8"(118)	1-3/8"(35)	1-5/4"(45)	2 oz.	1/16 oz.
1"	EYD-90T		5-1/2"(143)	1-3/4"(45)	2-1/8"(54)	4 oz.	1/8 oz.

\*Turning radius with plug removed.

HUB SIZE	CATALOG NUMBER		DIMENSIONS		TURNING RADIUS*	SEALING COMPOUND REQUIRED	PER HUB (FF)
	DURALLOY IRON		A	B			
1/2"	EYD-58M		3-1/2"(89)	1-1/8"(29)	1-5/8"(41)	1-1/4 oz.	1/22 oz.
3/4"	EYD-75M		3-3/4"(95)	1-3/8"(35)	1-5/4"(45)	2 oz.	1/16 oz.
1"	EYD-90M		4-3/8"(115)	1-3/4"(45)	2-1/8"(54)	4 oz.	1/8 oz.

\*Turning radius with plug removed.

HUB SIZE	CATALOG NUMBER		DIMENSIONS		TURNING RADIUS*	SEALING COMPOUND REQUIRED	PER HUB (FF)
	DURALLOY IRON		A	B			
1/2"	EYD-60TM		4-3/8"(115)	1-1/8"(29)	1-5/8"(41)	1-1/4 oz.	1/22 oz.
3/4"	EYD-75TM		4-5/8"(118)	1-3/8"(35)	1-5/4"(45)	2 oz.	1/16 oz.
1"	EYD-100TM		5-1/2"(143)	1-3/4"(45)	2-1/8"(54)	4 oz.	1/8 oz.

\*Turning radius with plug removed.



EYD



EYD with Nipple

# FITTINGS

ENY40/EYD40 SERIES



## 40% FILL SEALING FITTINGS



ENY



EYD

**ENY40-1, 2, 3, 4, 5**  
 Class I, Div. 1 & 2, Groups B, C, D  
 Class I, Zone 1, Groups II-B, II-A  
 Class II, Div. 1 & 2, Groups E, F, G  
 Class III

**ENY40-6, 7, 8, 9, 0**  
**EYD40 (1 through 0)-6, 7, 8, 9, 0**  
 Class I, Div. 1 & 2, Groups C, D  
 Class I, Zone 1, Groups II-B, II-A  
 Class II, Div. 1 & 2, Groups E, F, G  
 Class III

### FEATURES-SPECIFICATIONS

#### Application

To seal Rigid Conduit or IMC Raceways with up to 40% wire fill.

#### Features

- A 40% wire fill capacity
- Large openings with threaded closures to provide easy access to conduit hubs for making dams
- Integral bushing in conduit hubs to protect conductor insulation from damage
- Npt threaded hubs to ensure ground continuity
- Minimum turning radius

#### Material/Finish

**Copper-free Aluminum**  
 (less than 4/10 of 1%)

- Electrostatically applied powder coating

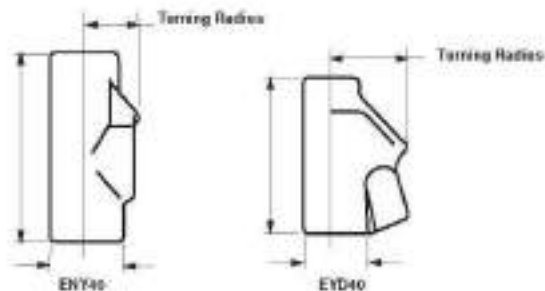
#### Duralloy Iron

- Tri-Coat finish of electrozinc, chromate sealant, and electrostatically applied powder coating

HUB SIZE	CATALOG NUMBER		DIMENSIONS		TURNING RADIUS*	REQUIRED SEALING COMPOUND & PACKING FIBER SZ.	PER HUB (PF)
	KILLARK ALUMINUM	DURALLOY IRON	A	B			
1/2"	ENY40-1	ENY40-1M	4-11/16" (113)	3-1/8" (76)	1-9/16" (40)	2	0.36
3/4"	ENY40-2	ENY40-2M	4-3/8" (112)	3-1/2" (90)	1-5/16" (39)	4	3.0
1"	ENY40-3	ENY40-3M	5-1/8" (137)	3-7/8" (100)	1-3/8" (44)	7	0.39
1-1/4"	ENY40-4	ENY40-4M	5-11/16" (144)	3-3/4" (95)	1-3/8" (44)	13	1.00
1-1/2"	ENY40-5	ENY40-5M	5-3/8" (142)	3-5/8" (93)	1-9/16" (40)	33	2.99
2"	ENY40-6	ENY40-6M	7-5/8" (194)	4-3/4" (121)	1-3/8" (44)	38	3.00
2-1/2"	ENY40-7	ENY40-7M	7-5/8" (194)	4-3/4" (121)	1-3/8" (44)	81	0.88
3"	ENY40-8	ENY40-8M	7-1/8" (181)	4-3/8" (112)	1-3/4" (45)	88	6.00
3-1/2"	ENY40-9	ENY40-9M	7-3/8" (188)	4-3/4" (121)	1-3/4" (45)	114	2.00
4"	ENY40-0	ENY40-0M	11-1/8" (285)	6-1/2" (163)	1-3/4" (45)	300	0.80

HUB SIZE	CATALOG NUMBER		DIMENSIONS		TURNING RADIUS*	REQUIRED SEALING COMPOUND & PACKING FIBER SZ.	PER HUB (PF)
	KILLARK ALUMINUM	DURALLOY IRON	A	B			
1/2"	EYD40-1	EYD40-1M	4-3/8" (112)	3-1/8" (76)	1-3/4" (45)	4	0.36
3/4"	EYD40-2	EYD40-2M	4-3/8" (112)	3-3/8" (90)	1-3/4" (45)	6	0.36
1"	EYD40-3	EYD40-3M	5-3/8" (142)	3-3/8" (90)	1-5/8" (41)	7	3.0
1-1/4"	EYD40-4	EYD40-4M	5-11/16" (144)	4-3/8" (112)	1-5/8" (41)	13	0.30
1-1/2"	EYD40-5	EYD40-5M	5-3/8" (142)	4-11/16" (144)	1-3/4" (45)	33	1.00
2"	EYD40-6	EYD40-6M	7-1/8" (181)	4-5/8" (117)	1-5/8" (41)	38	1.00
2-1/2"	EYD40-7	EYD40-7M	7-1/8" (181)	4-5/8" (117)	1-5/8" (41)	81	1.00
3"	EYD40-8	EYD40-8M	7-3/8" (188)	4-3/4" (121)	1-5/8" (41)	88	3.00
3-1/2"	EYD40-9	EYD40-9M	7-3/8" (188)	4-3/4" (121)	1-5/8" (41)	114	0.36
4"	EYD40-0	EYD40-0M	11-1/8" (285)	6-1/2" (163)	1-3/4" (45)	300	4.00

\*Turning radius with cover plug removed



# FITTINGS

SC/IF SERIES



## SEALING MATERIALS



Sealing Compound



Packing Fiber



SC11W

### FEATURES-SPECIFICATIONS Series SC/PF

#### Sealing Materials

SC Series Sealing compound is a cement used extensively for sealing conduit to prevent the spread of explosive gases. It is non-shrinking and a secure seal is formed. SC Series resists acids, water, oil, etc. It is UL Listed for use with Killark ENY, EY, and EYS Series. Also CSA certified for use with any CSA certified sealing fitting.

#### Packing Fiber

Killark's Packing Fiber is made from an environmentally safe, non-asbestos material. It is easy to use and forms a positive dam to hold compound (Killark SC Type) in ENY, EY, and EYS Series fittings.

#### Features of SC with Water

- Exact amount of compound and water are packaged together into a two-compartment plastic pouch.
- The precise amount of compound and water are available for mixing. No mixing or measure implements are required.
- Squeezing the inner water container forces the water into the compartment containing the sealing compound. Complete mixing takes place inside the plastic pouch.
- The mixed sealing compound can be poured directly into the sealing fitting. A tubular straw is provided for those difficult seals to reach.
- The package label indicates the size and quantity of sealing fittings each pouch will properly fill.

OUNCES REQUIRED PER FITTING				
RIB SIZE	SEALING COMPOUND			PACKING FIBER
	ENY	EYS	EYEND	
1/2"	1.5 oz.	3.0 oz.	1.0 oz.	1.00 oz.
3/4"	2.4 oz.	3.0 oz.	2.0 oz.	2.0 oz.
1"	3.8 oz.	6.0 oz.	4.5 oz.	3.0 oz.
1 1/4"	6.3 oz.	6.0 oz.	7.5 oz.	6.0 oz.
1 1/2"	8.8 oz.	17.5 oz.	12.0 oz.	3.0 oz.
2"	15.0 oz.	37.0 oz.	24.0 oz.	7.0 oz.
2 1/2"	—	42.0 oz.	44.0 oz.	9.0 oz.
3"	—	47.0 oz.	44.0 oz.	4.0 oz.
3 1/2"	—	55.0 oz.	75.0 oz.	6.0 oz.
4"	—	60.0 oz.	75.0 oz.	9.0 oz.

© ENY/EYS includes Air Lock Assembly or but block application(s).

SEALING COMPOUND	
CATALOG NUMBER	SIZE PACKAGE
SC-4 OZ	4oz.
SC-8 OZ	8oz.
SC-1 LB	1 lb.
SC-5 LB	5 lbs.

PACKING FIBER	
CATALOG NUMBER	SIZE PACKAGE
PF-2	2oz.
PF-4	4oz.
PF-16	1 lb.

CATALOG NUMBER	RIB SIZE	WILL FILL THE FOLLOWING SEALS:			OZ. W. FILL PER POUCH	NO. OF POUCHES PER CARTON
		ENY	EYS	EYEND		
SC5MD	1/2"	3	1	0	5	3
	3/4"	0	1	0		
	1"	1	—	1		
SC11WD	1/2"	7	0	11	11	5
	3/4"	0	0	0		
	1"	1	1	0		

© Appropriate amount of Packing Fiber is included in catalog. Additional Packing Fiber may be purchased separately.

**KILLARK**

WWW.FITTINGS-KILLARK.COM



# Contact US

---

In the event that a situation arises that is not covered by this manual, we encourage you to contact us so that we can help you resolve any issues you may have. Please have this manual readily available when calling for assistance.

For further information on our products or to access our most recently updated manuals and product catalogues, please visit our website at [www.envent-eng.com](http://www.envent-eng.com).

## Canada (Main)

Toll Free: 1 (877) 936 – 8368  
Tel: (403) 253-4012  
Fax: (403) 253 -4016  
Email: [info@envent-eng.com](mailto:info@envent-eng.com)

## USA

Tel: 1 (713) 567 – 4421

## China

Tel: 86 (138) 0119 – 1148

